



Signage Program Design Concepts for Moreno Valley College

Updated 6-22-2017



Designs by Ullrich Hepperlin
©2017 Access Communications

Introduction



The main inspiration for this signage program design was the MVC mascot and logo, namely the college's identity. The logo's shapes, colors and the image of the mountain lion is echoed in every part of this package, large or small.

Another source of design inspiration was the recently completed SAS building with its modern lines and clean geometric shapes harmonizing flowing curves with cubes, squares and rectangles.

Along with the MVC school color prevalent all over campus, we chose a very light cool gray for the main sign color. This choice is meant to help brighten up the interior hallways especially those that suffer from a lack of natural light. (e.g. the south facing lower floors of the library and student services buildings.)

Besides bringing the college's signage up to all applicable codes, this system also updates the entire campus with a fresh new modern look which harmonizes with both the new and older buildings.



- Background Color A
- Background Color B
- Graphics Color C
- Graphics Color D

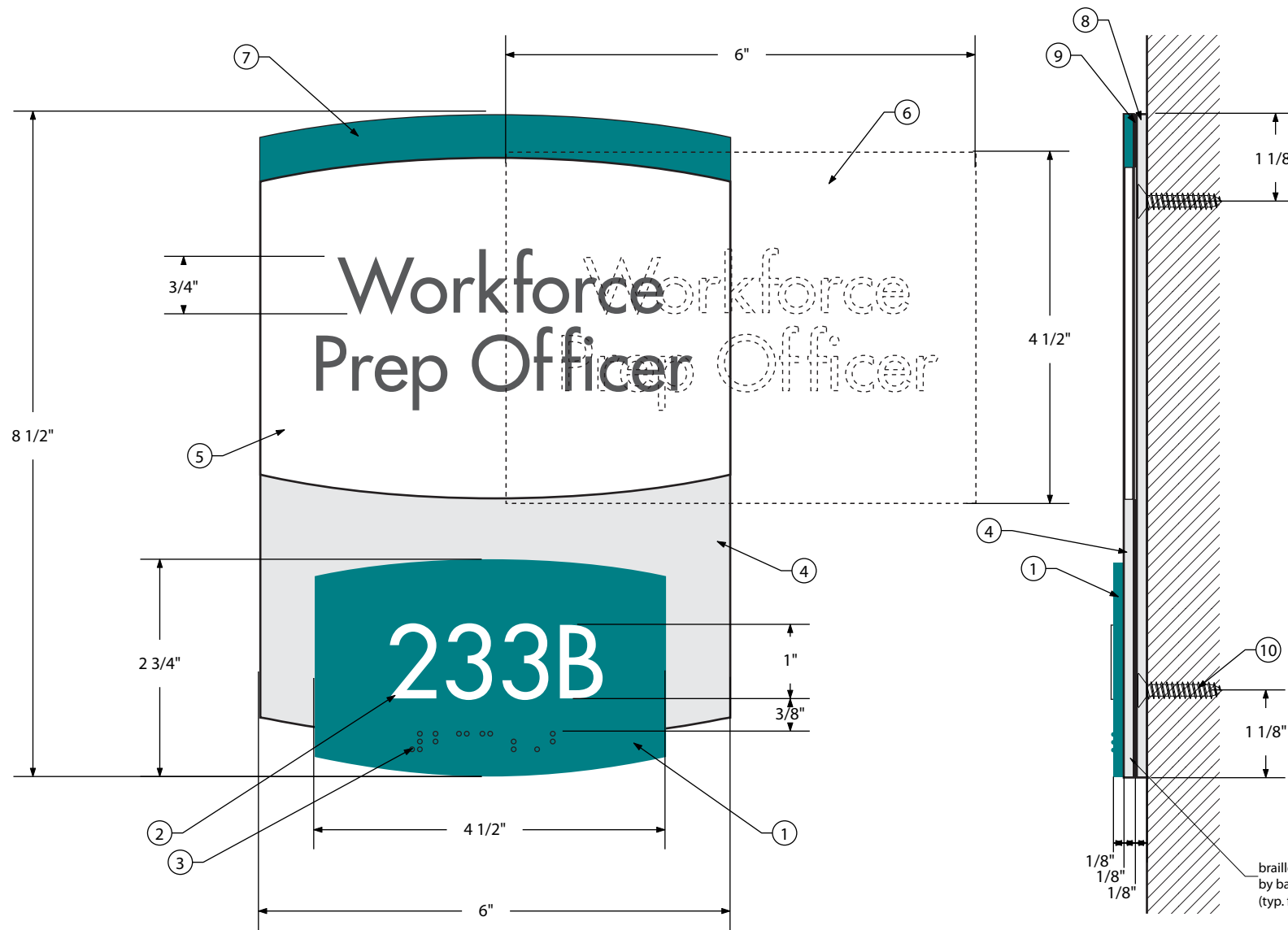

Key Notes:

- ① Braille & tactile plaque made from 1/8" thick clear thermoformed acrylic w/ non glare finish. All raised elements to be integral to plaque. All color to be applied sub-surface.
- ② Tactile characters integral to plaque. Raised 1/32" above the face of the sign. Text color applied on 2nd surface prior to painting.
- ③ Clear CA-compliant braille integral to plaque. Raised 1/40" above the face of the sign. Grade-2 translation.
- ④ Sign plaque made from 1/8" thick clear cast non-glare acrylic. All color to be applied sub-surface.
- ⑤ Window for name insert to be left unpainted.
- ⑥ Laser printed card stock insert to slide into the sign from the side.
- ⑦ Accent bar in school color
- ⑧ White acrylic backplate mounted to wall
- ⑨ 1/32" layer of foam adhesive to mount sign plaque on backplate. Window slot for name insert is left as void and framed by foam tape on top and bottom.
- ⑩ #8 x 1" corrosion resistant FH screws to mount countersunk backplate to wall.

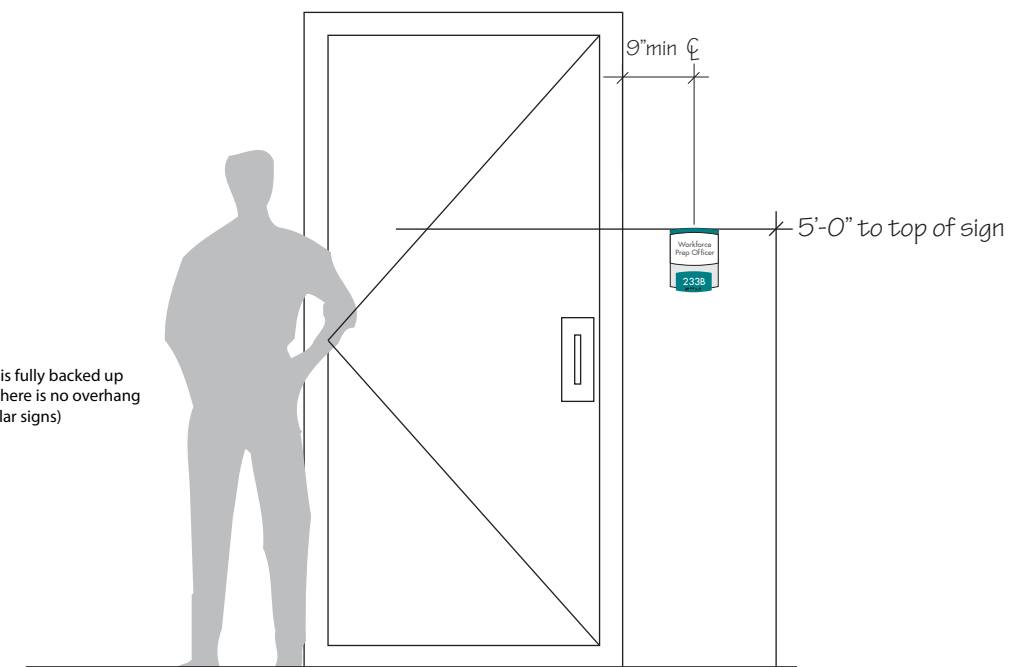

① Enlarged Elevation
Scale 1:2

② Section
Scale 1:2

③ Context Elevation
Scale 1/2" = 1'



**Room ID -
Window**

Sheet Size : 11"x17"

SG-1.0

- Background Color A
- Background Color B
- Graphics Color C
- Graphics Color D

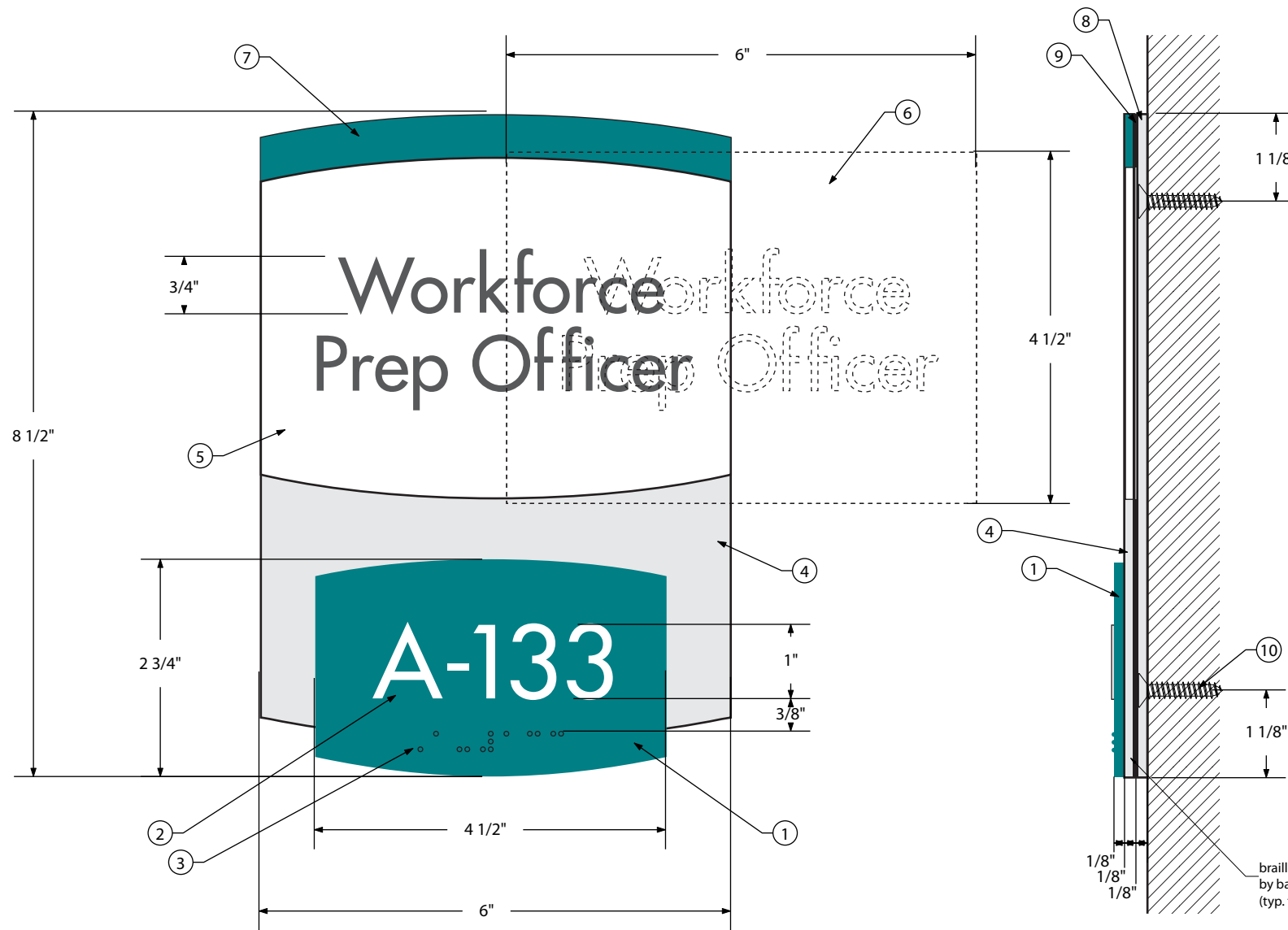

Key Notes:

- ① Braille & tactile plaque made from 1/8" thick clear thermoformed acrylic w/ non glare finish. All raised elements to be integral to plaque. All color to be applied sub-surface.
- ② Tactile characters integral to plaque. Raised 1/32" above the face of the sign. Text color applied on 2nd surface prior to painting.
- ③ Clear CA-compliant braille integral to plaque. Raised 1/40" above the face of the sign. Grade-2 translation.
- ④ Sign plaque made from 1/8" thick clear cast non-glare acrylic. All color to be applied sub-surface.
- ⑤ Window for name insert to be left unpainted.
- ⑥ 1/32" clear exterior grade plastic insert w/ black vinyl lettering. Fit must be snug to prevent moisture build-up between layers.
- ⑦ Accent bar in school color
- ⑧ White acrylic backplate mounted to wall
- ⑨ 1/32" thick clear acrylic spacer layer laminated between faceplate and backplate (use liquid or paper thin adhesive film) to create insert slot.
- ⑩ #8 x 1" corrosion resistant FH screws to mount countersunk backplate to wall.

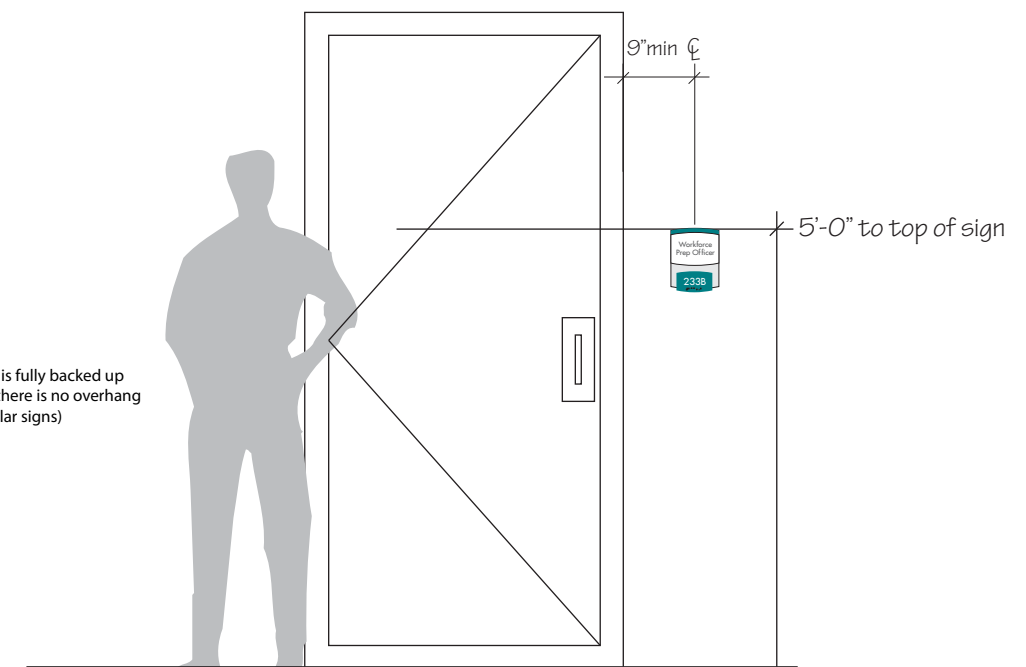

① Enlarged Elevation
Scale 1:2

② Section
Scale 1:2

③ Context Elevation
Scale 1/2" = 1'



**Room ID -
Window
Exterior**

Sheet Size : 11"x17"

SG-1.1

- Background Color A
- Background Color B
- Graphics Color C
- Graphics Color D

Access Communications
Signage Consultants
3700 Industry Ave #102
Lakewood, CA 90712
TEL (562) 423-6600
FAX (562) 981-8736

Project : Moreno Valley College
Signage Program
Client : RCCD
Contact :
Job No. :

Designer : Ullrich Hepperlin
Email: ullrich@tojico.com
Phone: (562) 212-9347

Revision : 002
Revision Date : 6-22-2017



**Corridor/
Vestibule Ids**

Sheet Size : 11"x17"

SG-1.2

Key Notes:

- ① Braille & tactile plaque made from 1/8" thick clear thermoformed acrylic w/ non glare finish. All raised elements to be integral to plaque. All color to be applied sub-surface.
- ② Tactile characters integral to plaque. Raised 1/32" above the face of the sign. Text color applied on 2nd surface prior to painting.
- ③ Clear CA-compliant braille integral to plaque. Raised 1/40" above the face of the sign. Grade-2 translation.
- ⑧ White acrylic backplate mounted to wall
- ⑨ 1/32" layer of foam adhesive to mount accent plaque on backplate.
- ⑩ #8 x 1" corrosion resistant FH screws to mount countersunk backplate to wall.

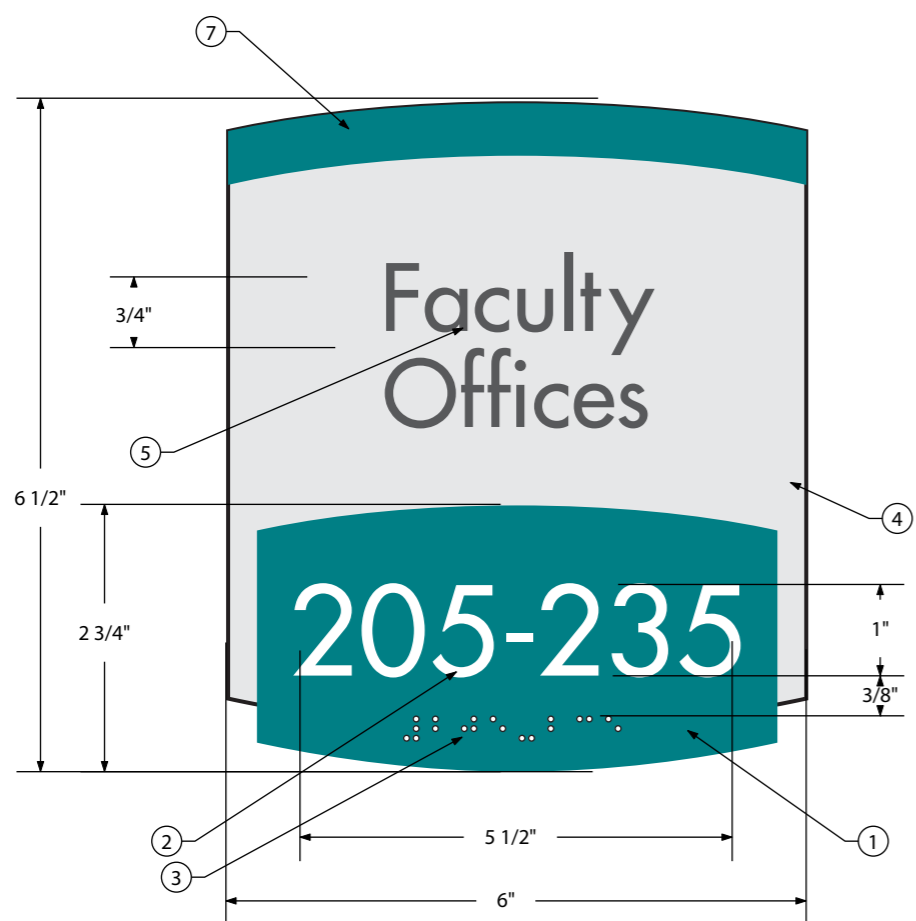

1A Enlarged Elevations (Numbered Clusters)
Scale 1:2

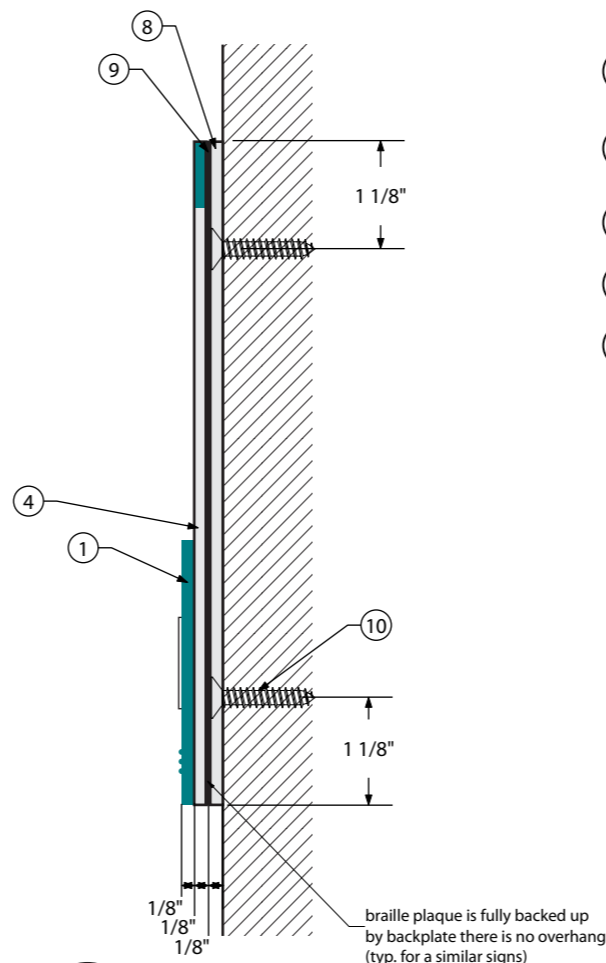

2A Section
Scale 1:2

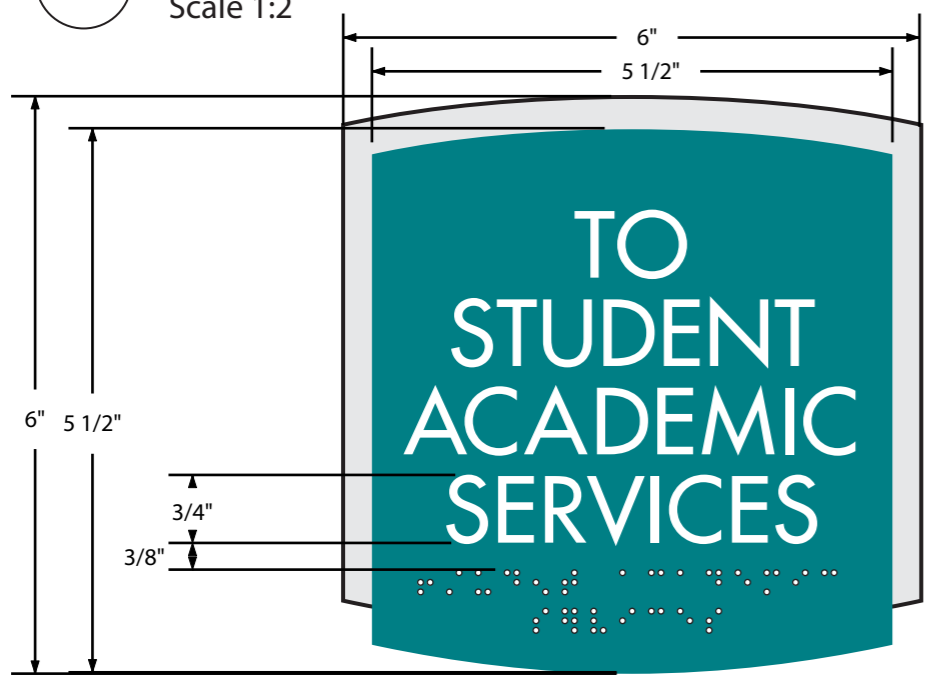

1B Enlarged Elevations (In between Buildings)
Scale 1:2

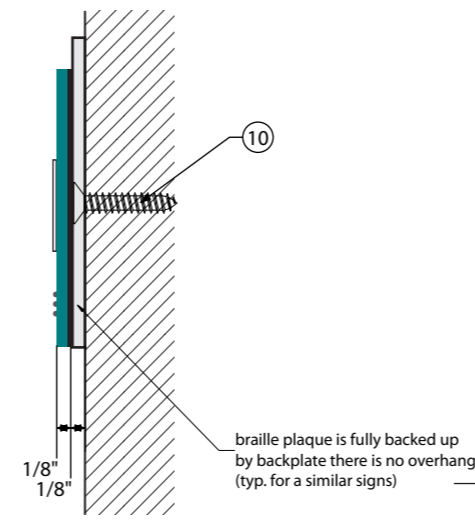

2B Section
Scale 1:2

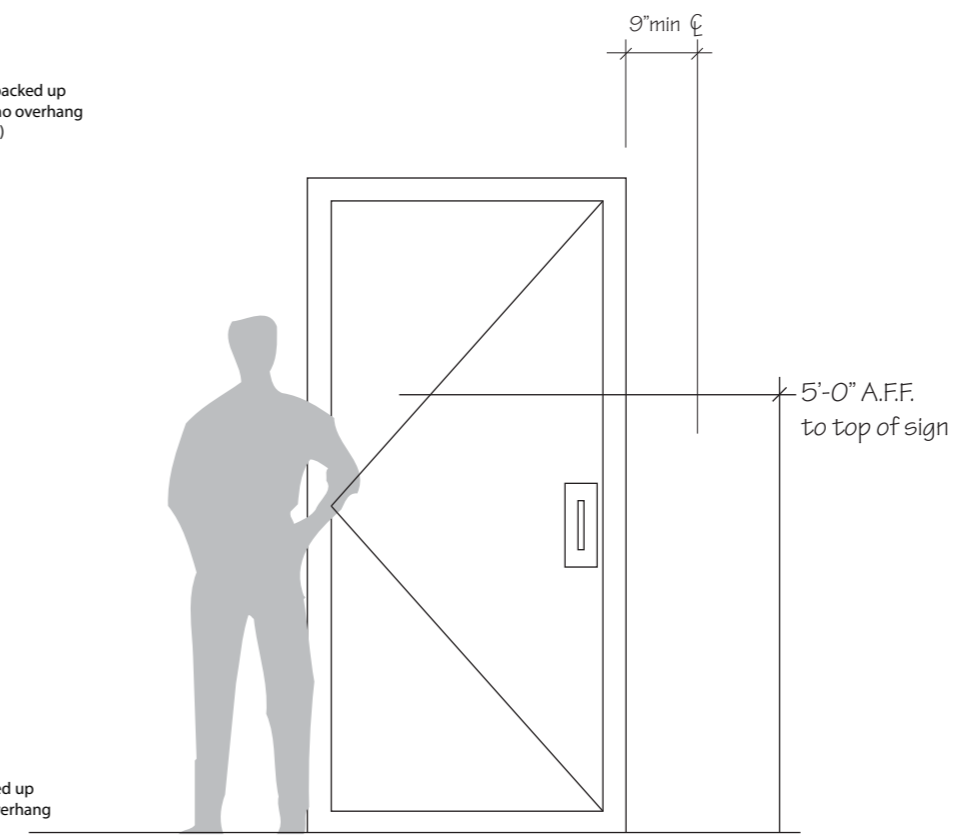

3 Context Elevation
Scale 1/2" = 1'

- Background Color A
- Background Color B
- Graphics Color C
- Graphics Color D

Access Communications

Signage Consultants
3700 Industry Ave #102
Lakewood, CA 90712
TEL (562) 423-6600
FAX (562) 981-8736

Project : Moreno Valley College
Signage Program

Client : RCCD

Contact :

Job No. :

Designer : Ullrich Hepperlin
Email: ullrich@tojico.com
Phone: (562) 212-9347

Revision : 002
Revision Date : 6-22-2017



**Room ID -
Utility**

Sheet Size : 11"x17"

SG-1.3

Key Notes:

- ① Braille & tactile plaque made from 1/8" thick clear thermoformed acrylic w/ non glare finish. All raised elements to be integral to plaque. All color to be applied sub-surface.
- ② Tactile characters integral to plaque. Raised 1/32" above the face of the sign. Text color applied on 2nd surface prior to painting.
- ③ Clear CA-compliant braille integral to plaque. Raised 1/40" above the face of the sign. Grade-2 translation.
- ④ Sign plaque made from 1/8" thick clear cast non-glare acrylic. All color & graphics to be applied sub-surface.
- ⑤ Subsurface cut-vinyl graphics for permanent room names.
- ⑦ not used
- ⑧ not used
- ⑨ 1/32" layer of foam adhesive to mount braille plaque to sign plaque.
- ⑩ #8 x 1" corrosion resistant FH screws to mount countersunk backplate to wall.

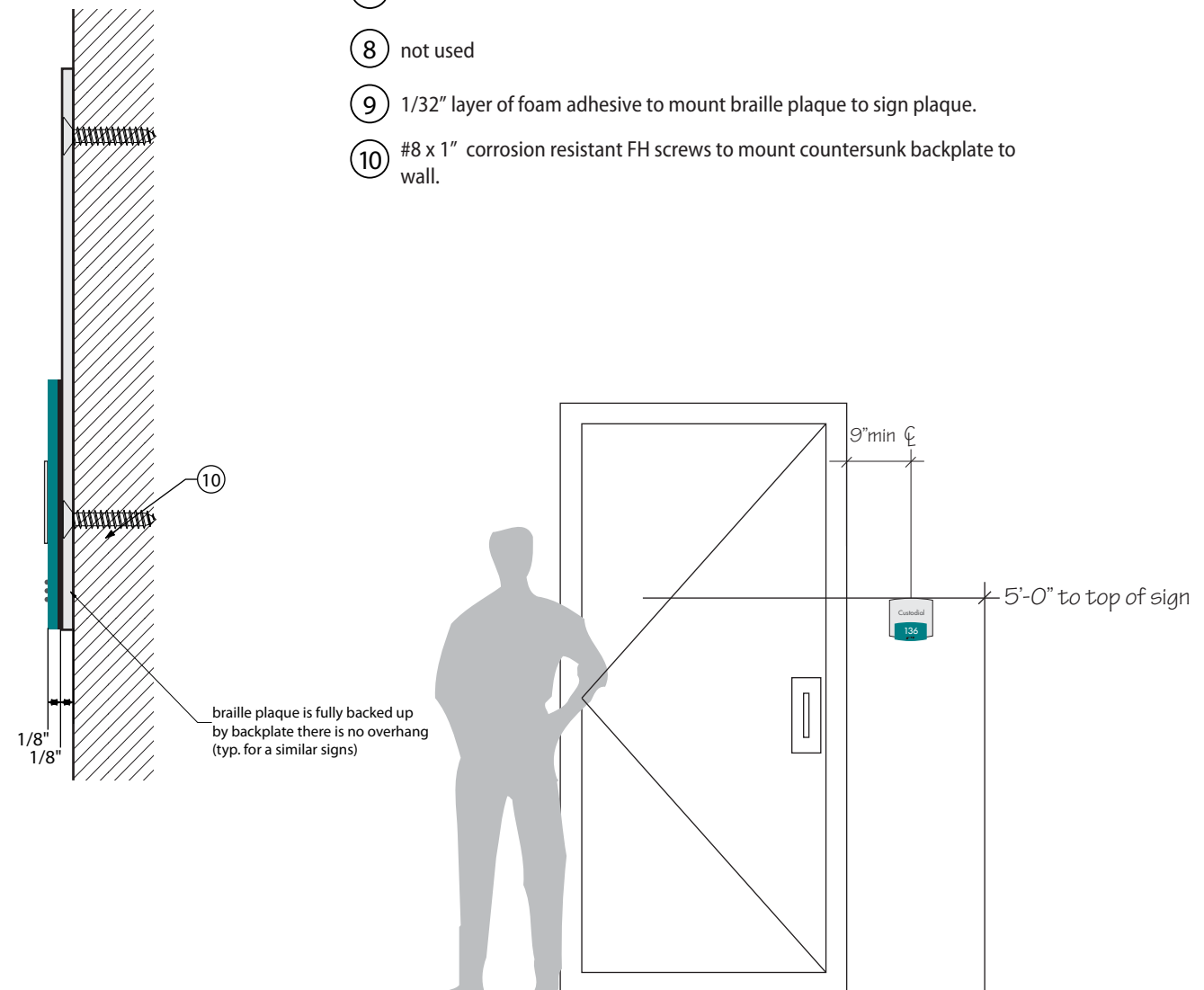
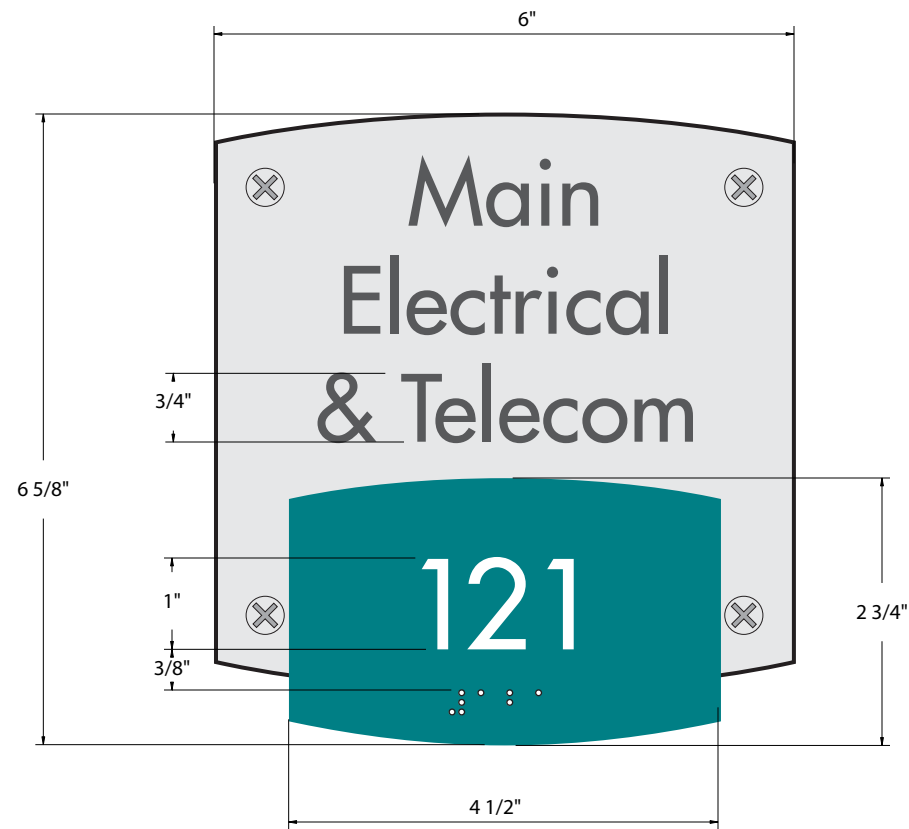

① Enlarged Elevation
Scale 1:2

② Section
Scale 1:2

③ Context Elevation
Scale 1/2" = 1'

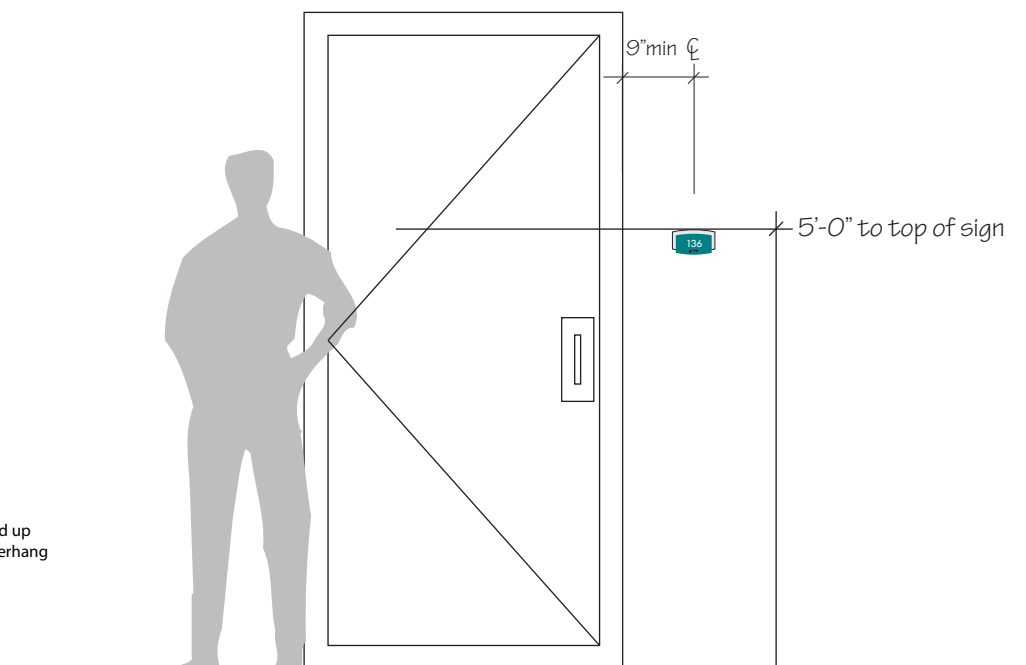
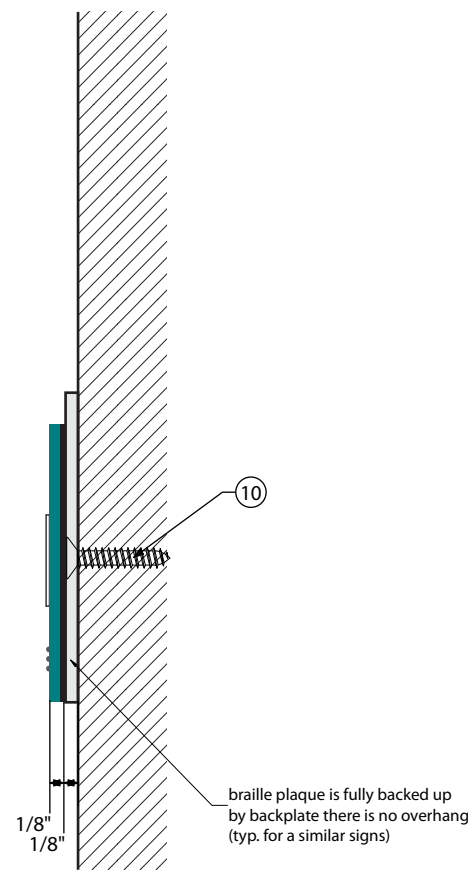
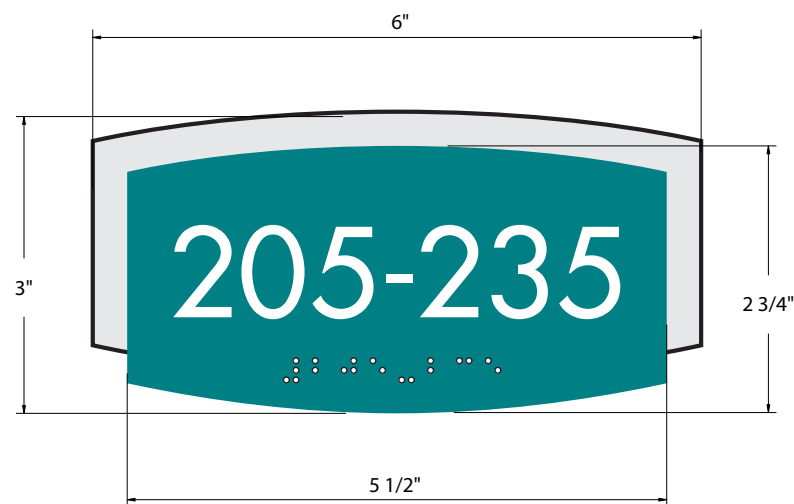
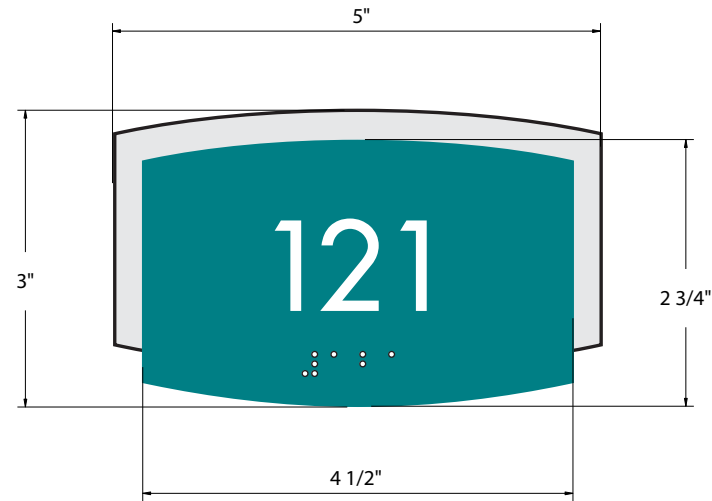
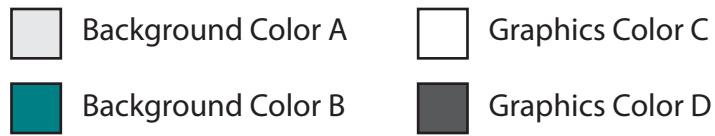

Key Notes:

- ① Braille & tactile plaque made from 1/8" thick clear thermoformed acrylic w/ non glare finish. All raised elements to be integral to plaque. All color to be applied sub-surface.
- ② Tactile characters integral to plaque. Raised 1/32" above the face of the sign. Text color applied on 2nd surface prior to painting.
- ③ Clear CA-compliant braille integral to plaque. Raised 1/40" above the face of the sign. Grade-2 translation.
- ④ Sign plaque made from 1/8" thick clear cast non-glare acrylic. All color & graphics to be applied sub-surface.
- ⑤ Subsurface cut-vinyl graphics for permanent room names.
- ⑦ not used
- ⑧ not used
- ⑨ 1/32" layer of foam adhesive to mount sign plaque on backplate.
- ⑩ #8 x 1" corrosion resistant FH screws to mount countersunk backplate to wall.

① Enlarged Elevation
Scale 1:2

② Section
Scale 1:2

③ Context Elevation
Scale 1/2" = 1'



**Room ID -
Number
/ Number
Range**

Sheet Size : 11"x17"

SG-1.4

- Background Color A
- Background Color B
- Graphics Color D

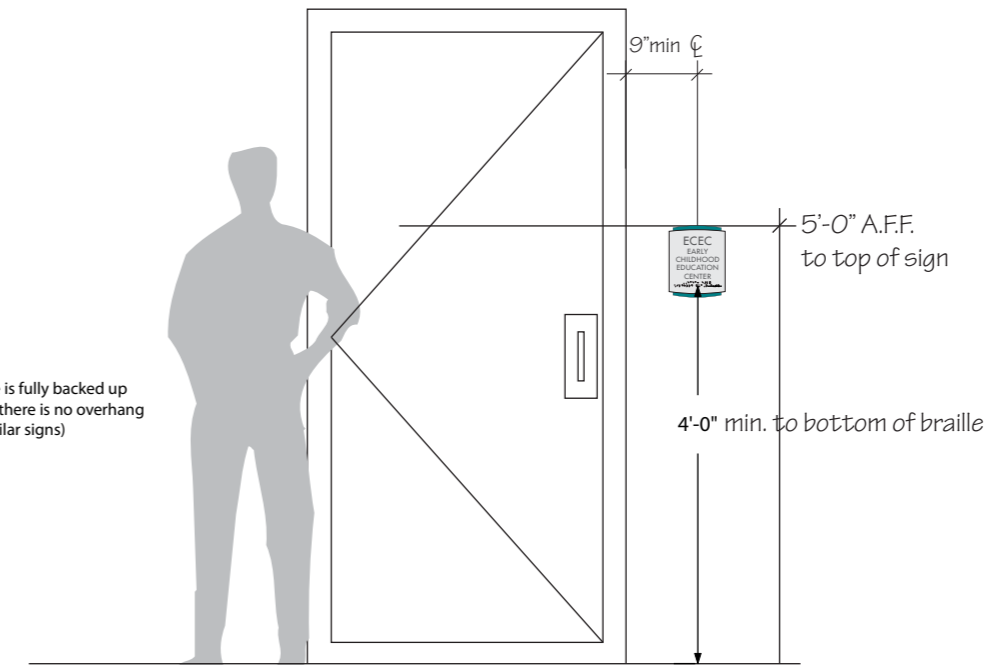
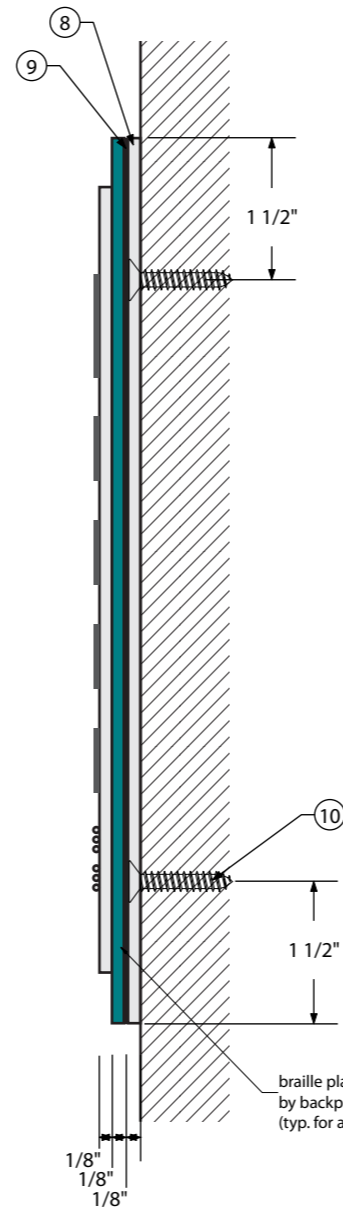
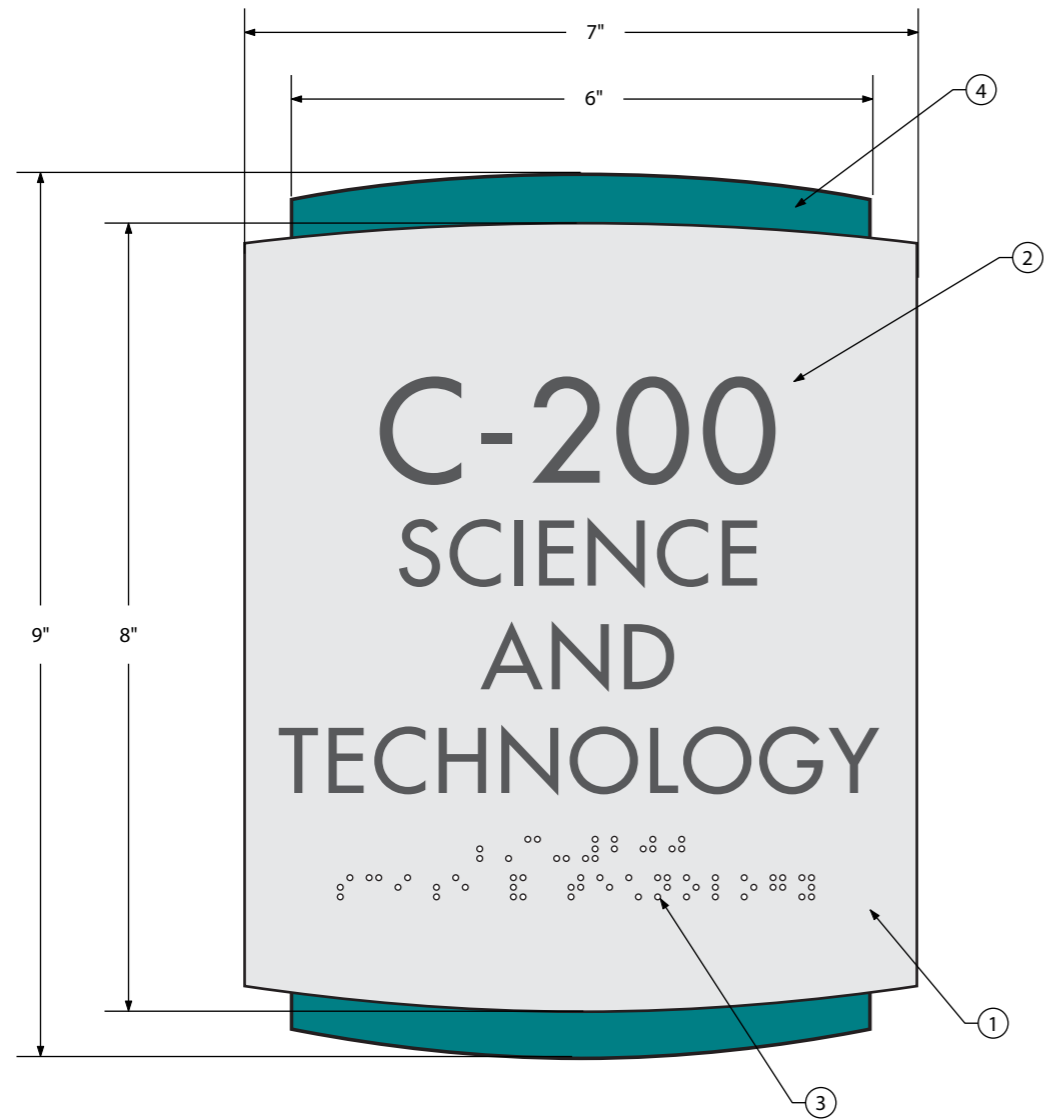

Key Notes:

- ① Braille & tactile plaque made from 1/8" thick clear thermoformed acrylic w/ non glare finish. All raised elements to be integral to plaque. All color to be applied sub-surface.
- ② Tactile characters integral to plaque. Raised 1/32" above the face of the sign. Text color applied on 2nd surface prior to painting.
- ③ Clear CA-compliant braille integral to plaque. Raised 1/40" above the face of the sign. Grade-2 translation.
- ④ Accent plaque made from 1/8" thick clear cast non-glare acrylic. All color to be applied sub-surface.
- ⑧ White backplate mounted to wall acrylic for smooth walls, alum. for rough walls
- ⑨ 1/32" layer of foam adhesive to mount accent plaque on backplate.
- ⑩ #8 x 1" corrosion resistant FH screws to mount countersunk backplate to wall.

① Enlarged Elevation
Scale 1:2

② Section
Scale 1:2

③ Context Elevation
Scale 1/2" = 1'



Building ID

Sheet Size : 11"x17"

SG-1.5

Access Communications

Signage Consultants
3700 Industry Ave #102
Lakewood, CA 90712
TEL (562) 423-6600
FAX (562) 981-8736

Project : Moreno Valley College
Signage Program

Client : RCCD

Contact :

Job No. :

Designer : Ullrich Hepperlin
Email: ullrich@tojico.com
Phone: (562) 212-9347

Revision : 002
Revision Date : 6-22-2017



**ECEC
Preschool
Classroom
Identification**

Sheet Size : 11"x17"

SG-1.6

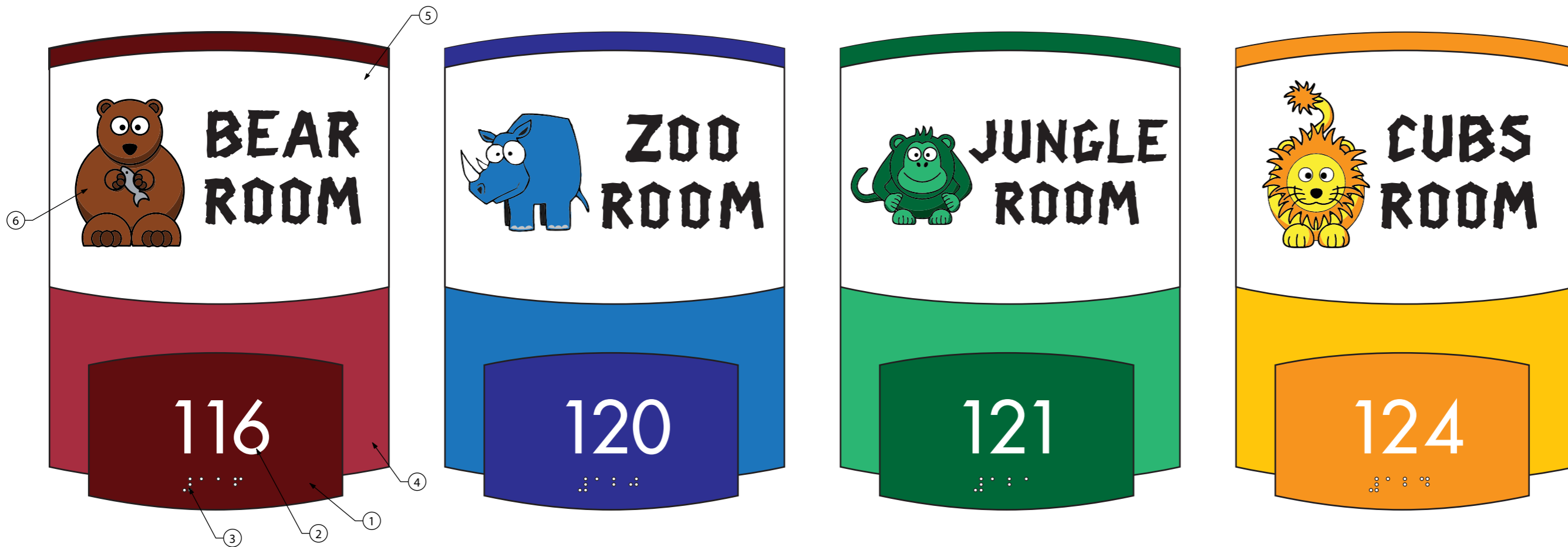

for dimensions & section drawing see DRW-002

1 Enlarged Elevations

Scale 1:2

Key Notes:

- ① Braille & tactile plaque made from 1/8" thick clear thermoformed acrylic w/ non glare finish. All raised elements to be integral to plaque. All color to be applied sub-surface.
- ② Tactile characters integral to plaque. Raised 1/32" above the face of the sign. Text color applied on 2nd surface prior to painting.
- ③ Clear CA-compliant braille integral to plaque. Raised 1/40" above the face of the sign. Grade-2 translation.
- ④ Sign plaque made from 1/8" thick clear cast non-glare acrylic. All color to be applied sub-surface.
- ⑤ Window for name insert to be left unpainted.
- ⑥ Laser printed card stock insert to slide into the sign from the side.

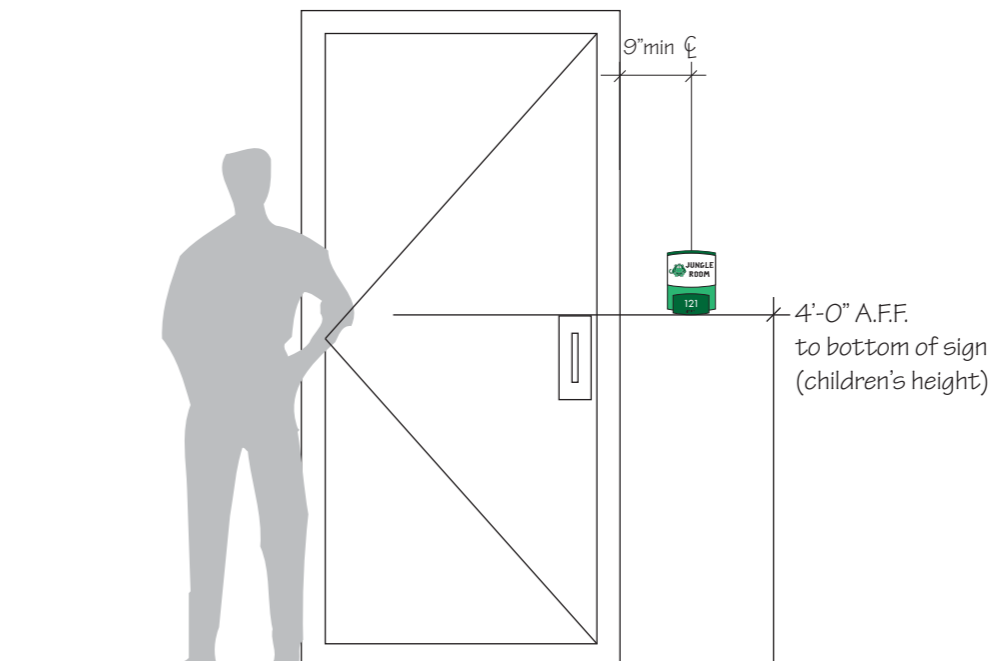

3 Context Elevation

Scale 1/2" = 1'

Background Color A

Graphics Color D

Access Communications Signage Consultants 3700 Industry Ave #102 Lakewood, CA 90712 TEL (562) 423-6600 FAX (562) 981-8736

Project : Moreno Valley College Signage Program Client : RCCD Contact : Job No. :

Designer : Ullrich Hepperlin Email: ullrich@tojico.com Phone: (562) 212-9347

Revision : 002 Revision Date : 6-22-2017



Floor Level ID (Stairwells)

Sheet Size : 11"x17"

SG-2.0

Key Notes:

- ① Braille & tactile plaque made from 1/8" thick clear thermoformed acrylic w/ non glare finish. All raised elements to be integral to plaque. All color to be applied sub-surface.
- ② Tactile characters integral to plaque. Raised 1/32" above the face of the sign. Text color applied on 2nd surface prior to painting.
- ③ Clear CA-compliant braille integral to plaque. Raised 1/40" above the face of the sign. Grade-2 translation.
- ⑧ White acrylic backplate mounted to wall
- ⑨ 1/32" layer of foam adhesive to mount accent plaque on backplate.
- ⑩ #8 x 1" corrosion resistant FH screws to mount countersunk backplate to wall.

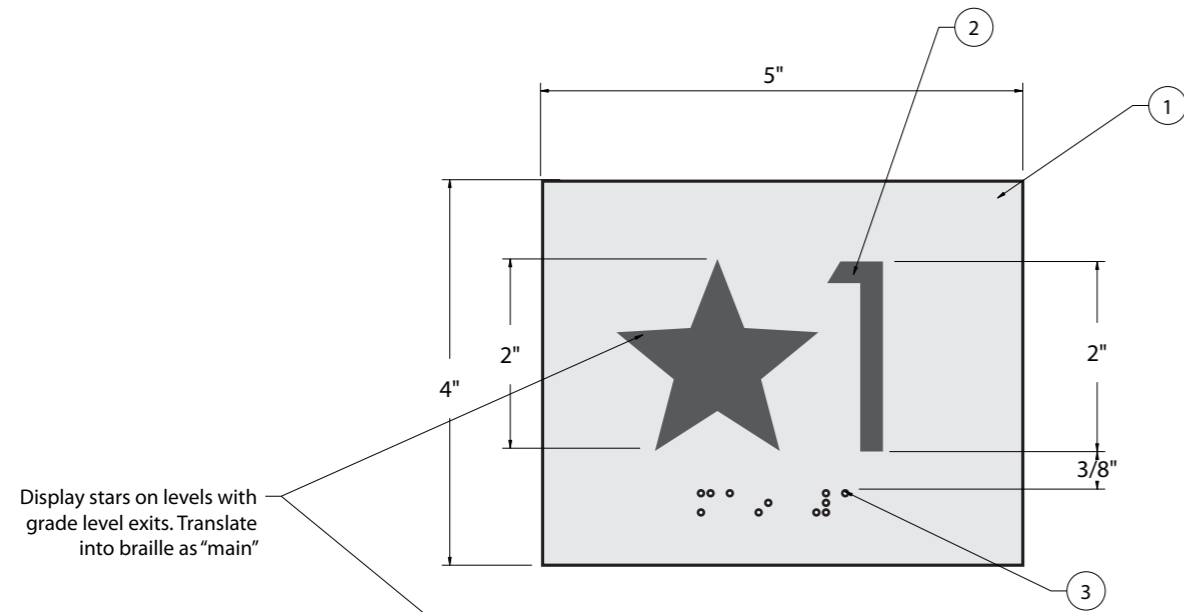

Display stars on levels with grade level exits. Translate into braille as "main"

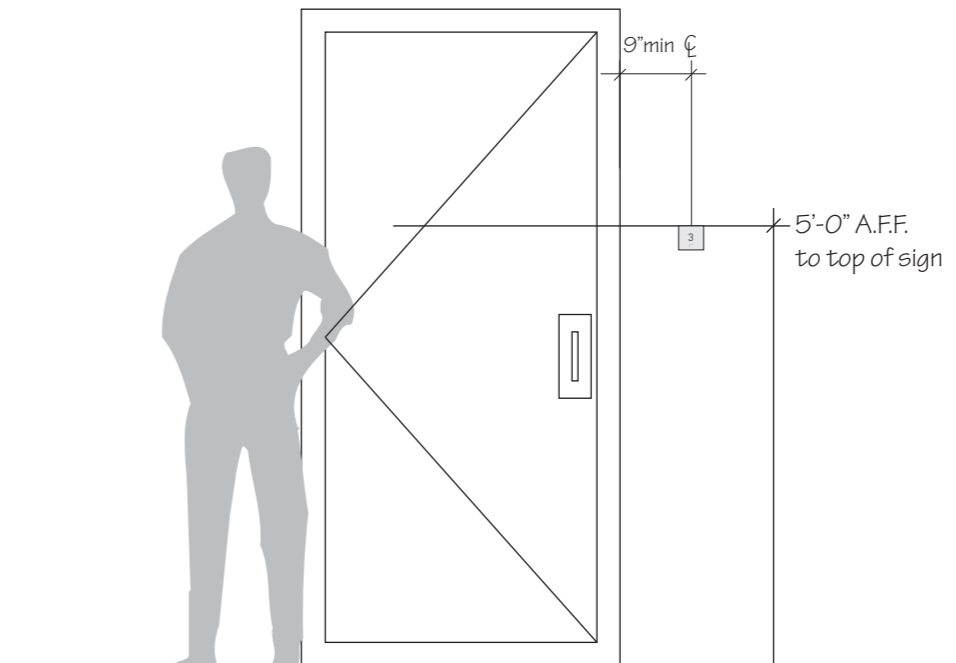
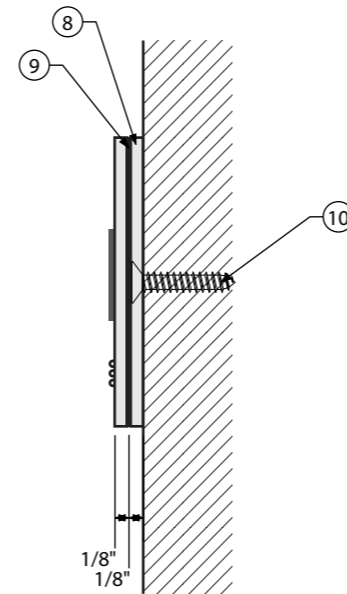
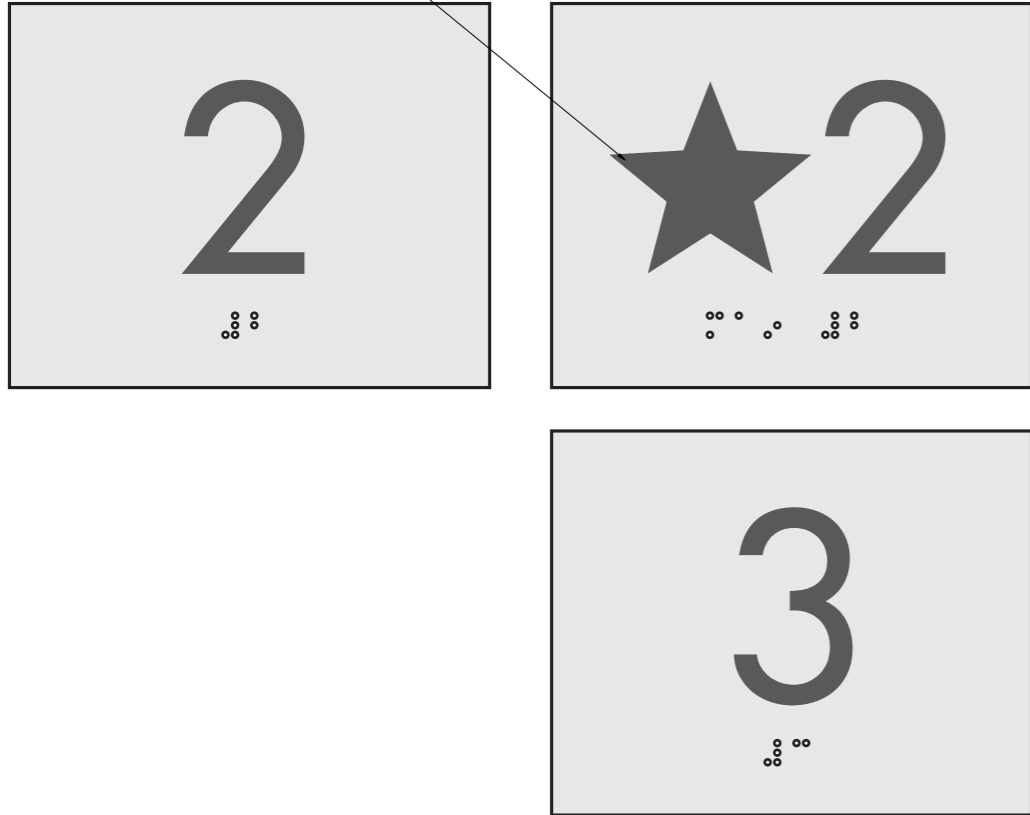

1 Enlarged Elevations Scale 1:2

2 Section Scale 1:2

3 Context Elevation Scale 1/2" = 1'

■ Background Color C

□ Graphics Color C

Access Communications

Signage Consultants
3700 Industry Ave #102
Lakewood, CA 90712
TEL (562) 423-6600
FAX (562) 981-8736

Project : Moreno Valley College
Signage Program

Client : RCCD

Contact :

Job No. :

Designer : Ullrich Hepperlin
Email: ullrich@tojico.com
Phone: (562) 212-9347

Revision : 002
Revision Date : 6-22-2017



**Floor Level ID
(Elevators)**

Sheet Size : 11"x17"

SG-2.1

Key Notes:

- ① Braille & tactile plaque made from 1/8" thick clear thermoformed acrylic w/ non glare finish. All raised elements to be integral to plaque. All color to be applied sub-surface.
- ② Tactile characters integral to plaque. Raised 1/32" above the face of the sign. Text color applied on 2nd surface prior to painting.
- ③ Clear CA-compliant braille integral to plaque. Raised 1/40" above the face of the sign. Grade-2 translation.
- ⑧ not used
- ⑨ 1/32" layer of foam adhesive to mount sign to hoistway
- ⑩ not used

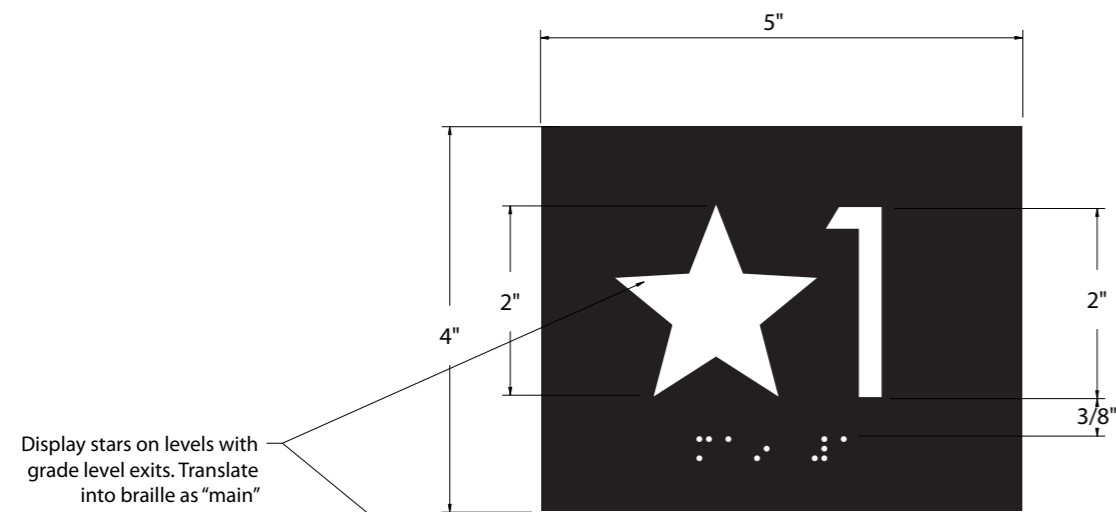

Display stars on levels with grade level exits. Translate into braille as "main"

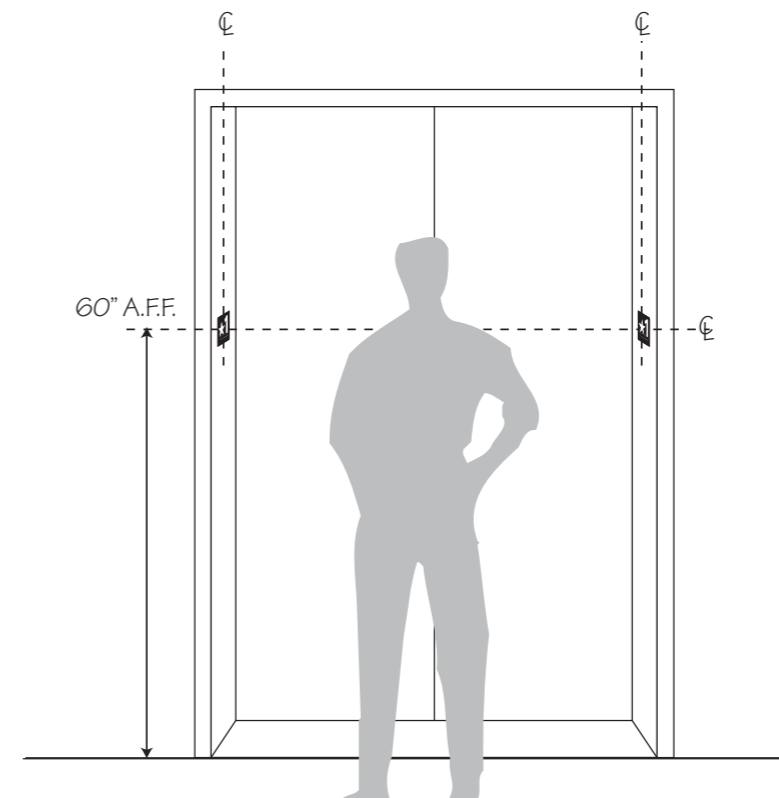
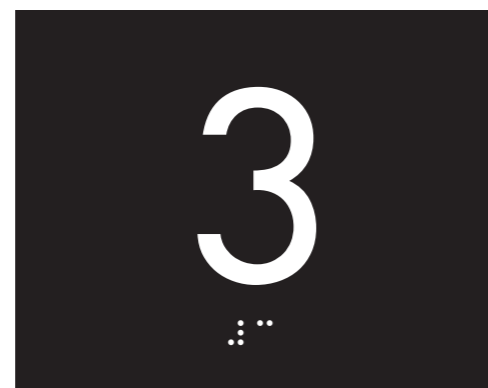

① Enlarged Elevations
Scale 1:2

② Section
Scale 1:2

③ Context Elevation
Scale 1/2" = 1'

Background Color A Graphics Color D

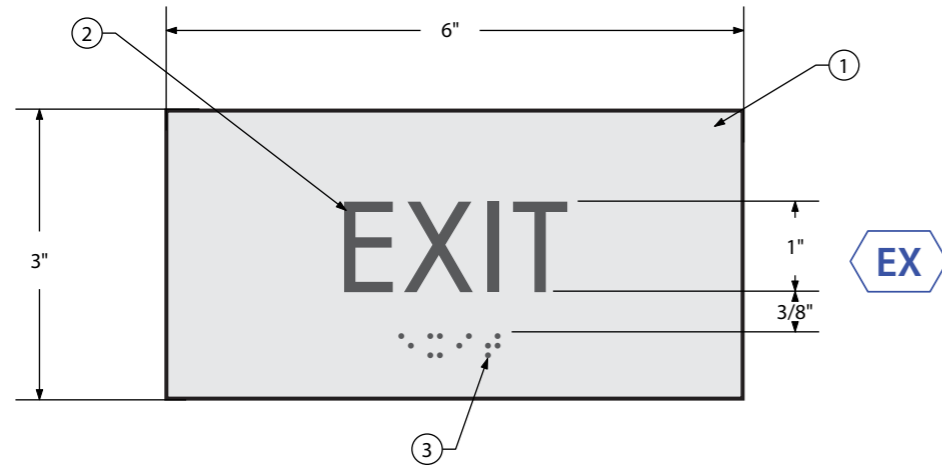

1A Enlarged Elevations
Scale 1:2

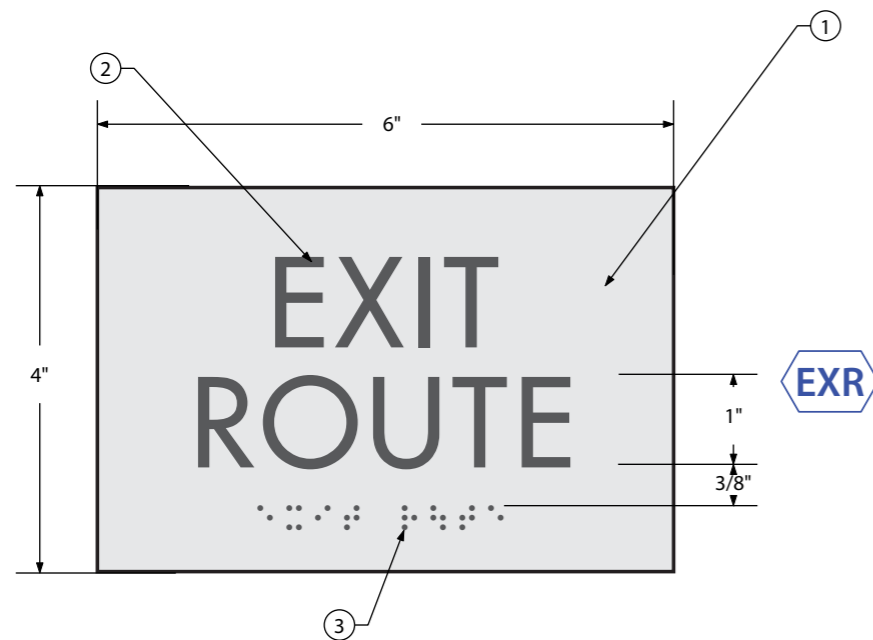

1B Enlarged Elevations
Scale 1:2

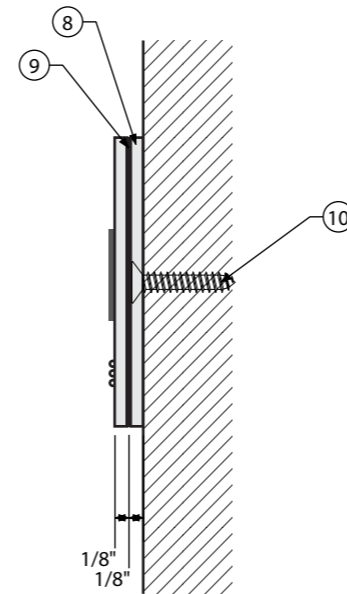

2 Section
Scale 1:2

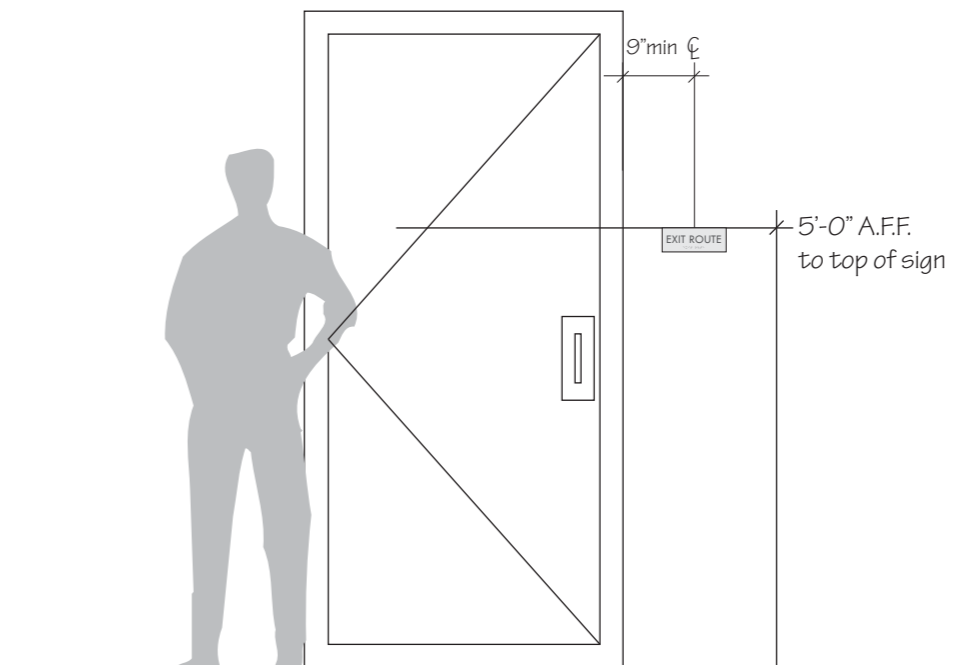

3 Context Elevation
Scale 1/2" = 1'

Key Notes:

- 1 Braille & tactile plaque made from 1/8" thick clear thermoformed acrylic w/ non glare finish. All raised elements to be integral to plaque. All color to be applied sub-surface.
- 2 Tactile characters integral to plaque. Raised 1/32" above the face of the sign. Text color applied on 2nd surface prior to painting.
- 3 Clear CA-compliant braille integral to plaque. Raised 1/40" above the face of the sign. Grade-2 translation.
- 8 White acrylic backplate mounted to wall
- 9 1/32" layer of foam adhesive to mount accent plaque on backplate.
- 10 #8 x 1" corrosion resistant FH screws to mount countersunk backplate to wall.



Exit & Exit Route

Sheet Size : 11"x17"

SG-3.0

Background Color A Graphics Color D

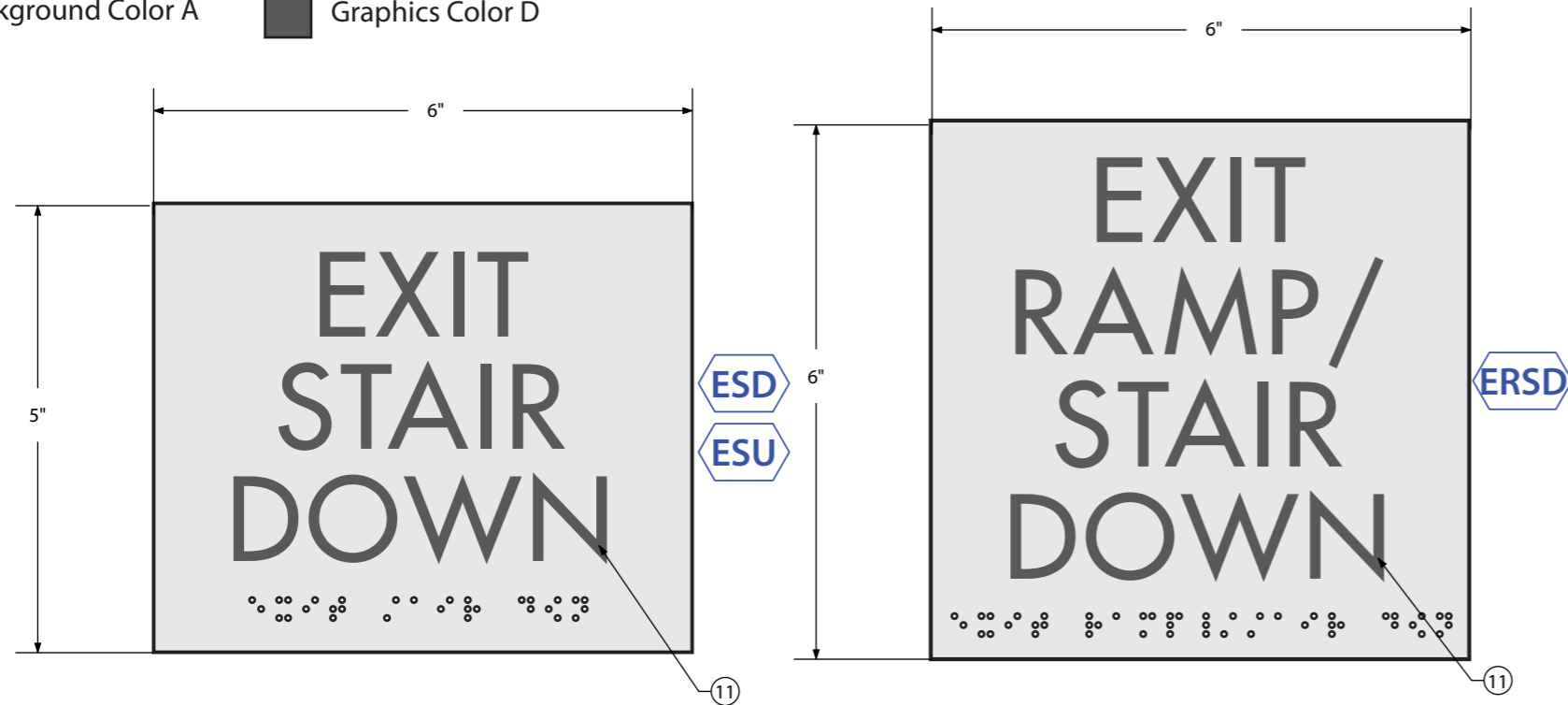

1A Enlarged Elevations
Scale 1:2

1B Enlarged Elevations
Scale 1:2

Key Notes:

- 1 Braille & tactile plaque made from 1/8" thick clear thermoformed acrylic w/ non glare finish. All raised elements to be integral to plaque. All color to be applied sub-surface.
- 2 Tactile characters integral to plaque. Raised 1/32" above the face of the sign. Text color applied on 2nd surface prior to painting.
- 3 Clear CA-compliant braille integral to plaque. Raised 1/40" above the face of the sign. Grade-2 translation.
- 8 White acrylic backplate mounted to wall
- 9 1/32" layer of foam adhesive to mount accent plaque on backplate.
- 10 #8 x 1" corrosion resistant FH screws to mount countersunk backplate to wall.
- 11 Use words "UP" or "DOWN" depending on field conditions.

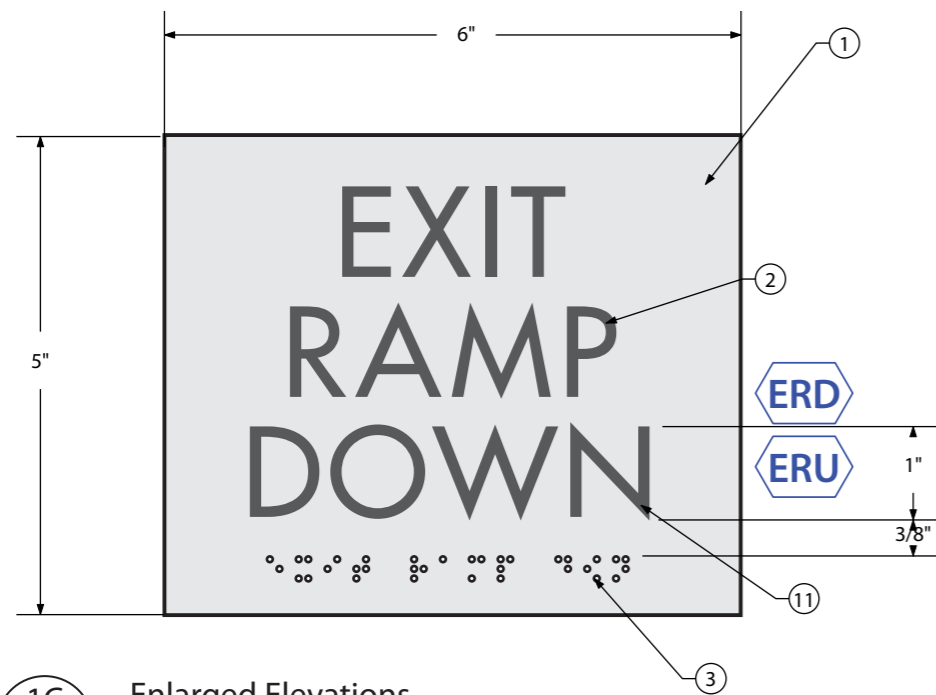

1C Enlarged Elevations
Scale 1:2

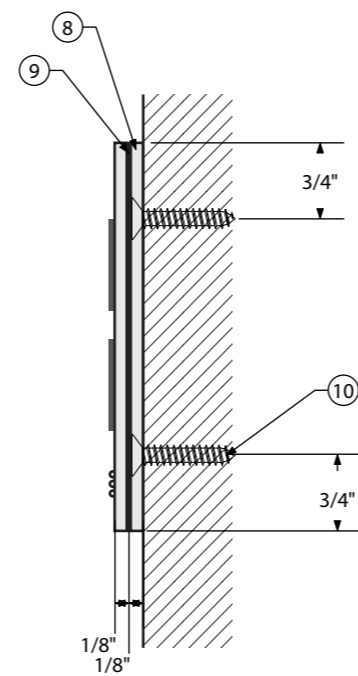

2 Section
Scale 1:2

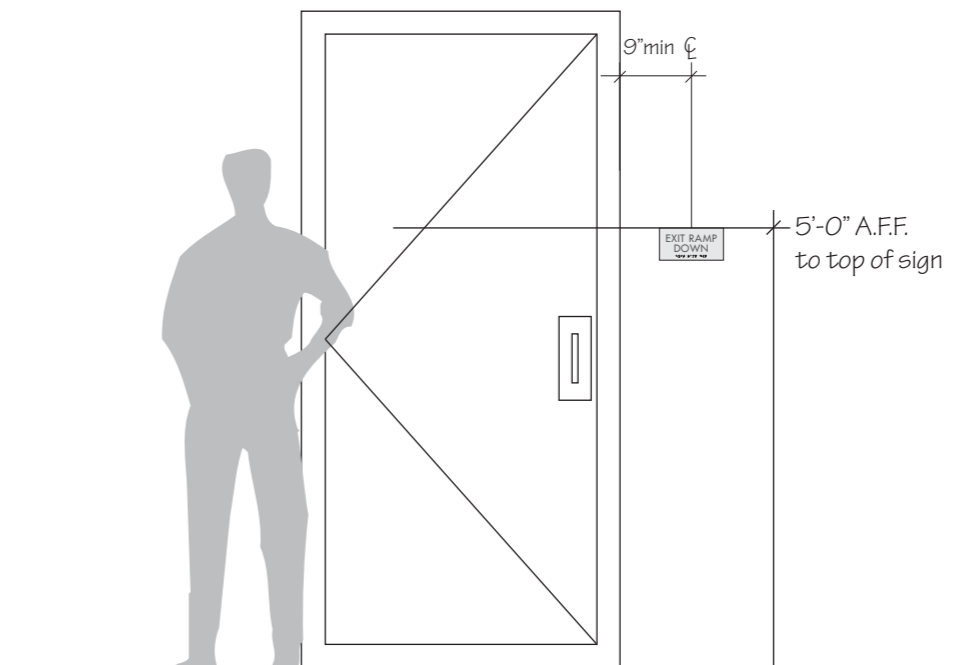

3 Context Elevation
Scale 1/2" = 1'

Access Communications

Signage Consultants
3700 Industry Ave #102
Lakewood, CA 90712
TEL (562) 423-6600
FAX (562) 981-8736

Project : Moreno Valley College
Signage Program

Client : RCCD

Contact :

Job No. :

Designer : Ullrich Hepperlin
Email: ullrich@tojico.com
Phone: (562) 212-9347

Revision : 002
Revision Date : 6-22-2017



Exit Stair /
Exit Ramp

Sheet Size : 11"x17"

SG-3.1

- Background Color A
- Background Color B
- Graphics Color C
- Graphics Color D

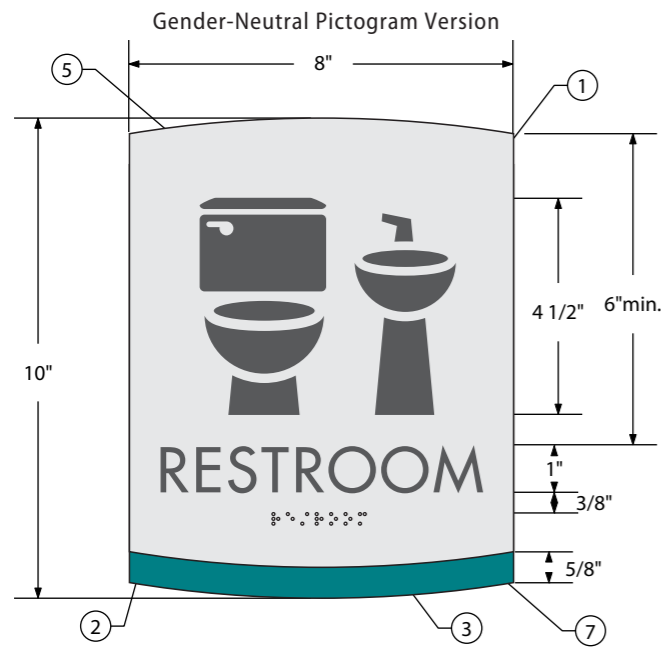

1A Enlarged Elevations
Scale 1:4



Pre-School Pictogram Version

1B Enlarged Elevations
Scale 1:4

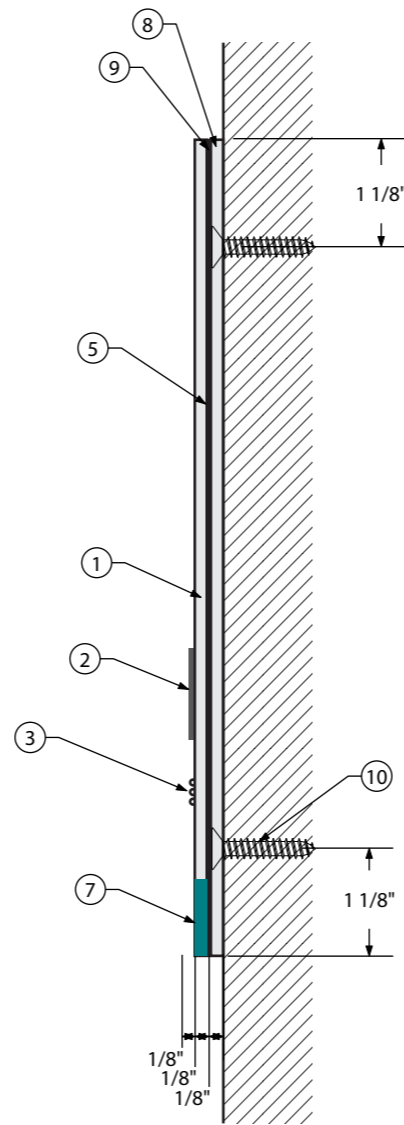

2 Section
Scale 1:2

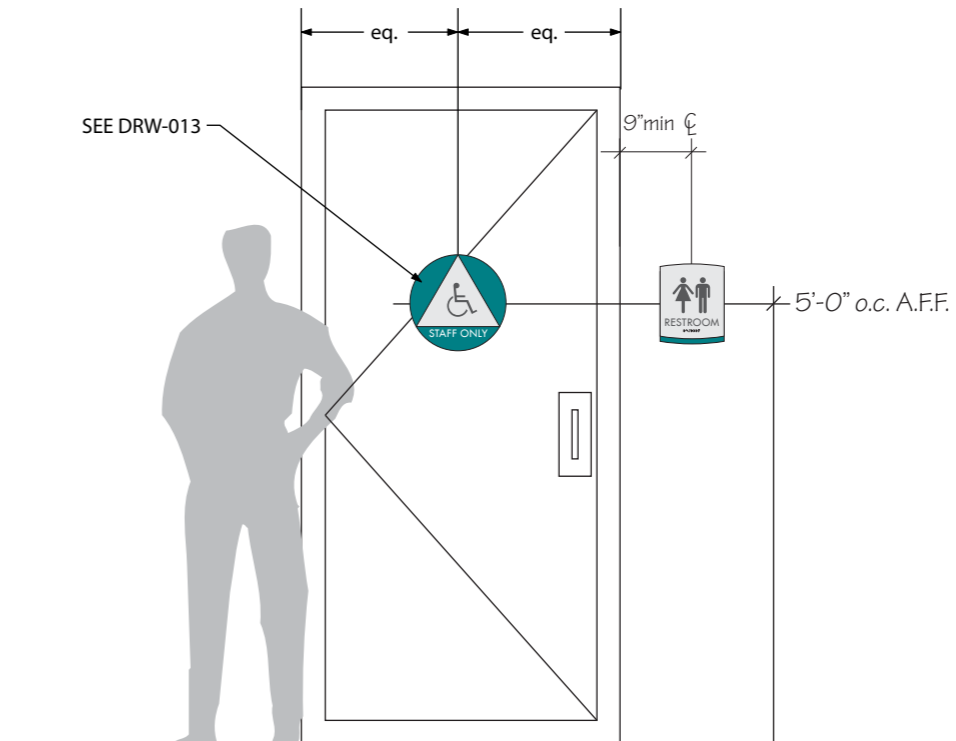

3 Context Elevation
Scale 1/2" = 1'

Key Notes:

- ① Braille & tactile plaque made from 1/8" thick clear thermoformed acrylic w/ non glare finish. All raised elements to be integral to plaque. All color to be applied sub-surface.
- ② Tactile characters integral to plaque. Raised 1/32" above the face of the sign. Text color applied on 2nd surface prior to painting.
- ③ Clear CA-compliant braille integral to plaque. Raised 1/40" above the face of the sign. Grade-2 translation.
- ④ not used
- ⑤ Subsurface cut-vinyl graphics for pictograms
- ⑦ Accent bar in school color
- ⑧ White acrylic backplate mounted to wall
- ⑨ 1/32" layer of foam adhesive to mount sign plaque on backplate.
- ⑩ #8 x 1" corrosion resistant FH screws to mount countersunk backplate to wall.



**Unisex
Restroom
Wall Signs**

Sheet Size : 11"x17"

SG-4.0

- Background Color A
- Background Color B
- Graphics Color C
- Graphics Color D

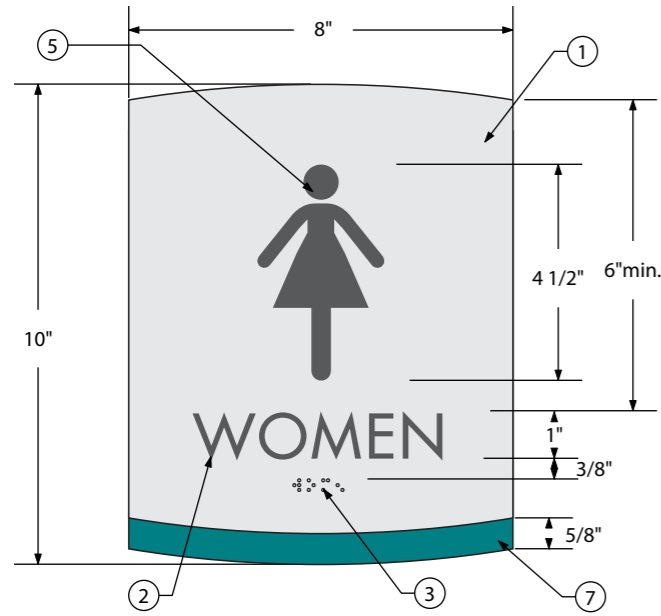

1A Enlarged Elevations
Scale 1:4



1B Enlarged Elevations
Scale 1:4

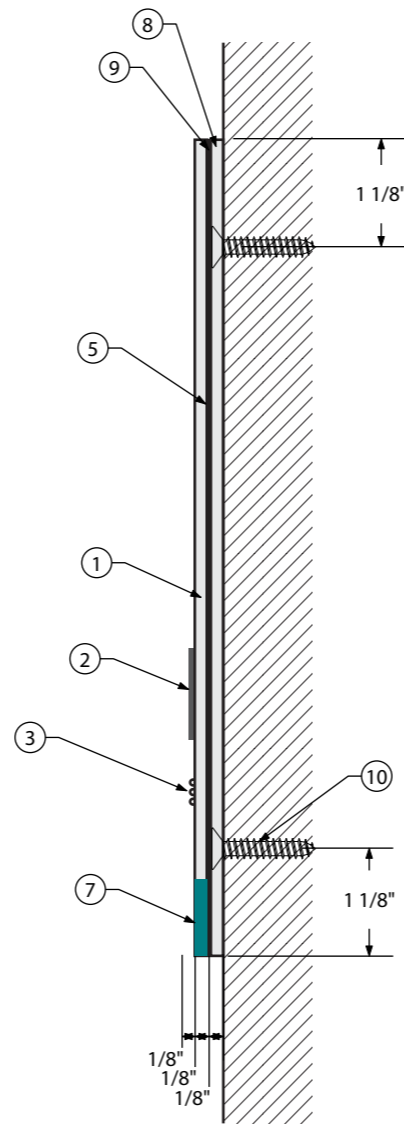

2 Section
Scale 1:2

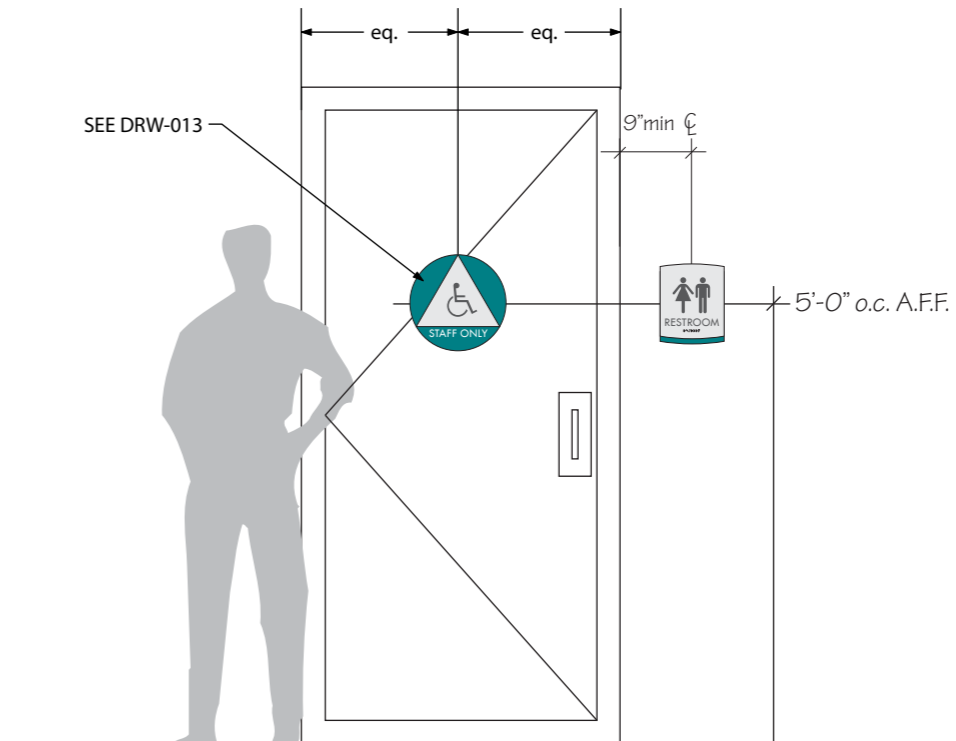

3 Context Elevation
Scale 1/2" = 1'

- Key Notes:
- 1 Braille & tactile plaque made from 1/8" thick clear thermoformed acrylic w/ non glare finish. All raised elements to be integral to plaque. All color to be applied sub-surface.
 - 2 Tactile characters integral to plaque. Raised 1/32" above the face of the sign. Text color applied on 2nd surface prior to painting.
 - 3 Clear CA-compliant braille integral to plaque. Raised 1/40" above the face of the sign. Grade-2 translation.
 - 4 not used
 - 5 Subsurface cut-vinyl graphics for pictograms
 - 7 Accent bar in school color
 - 8 White acrylic backplate mounted to wall
 - 9 1/32" layer of foam adhesive to mount sign plaque on backplate.
 - 10 #8 x 1" corrosion resistant FH screws to mount countersunk backplate to wall.



**Men/Women
Restroom
Wall Signs**

Sheet Size : 11"x17"

SG-4.1

- Background Color A
- Background Color B
- Graphics Color C
- Graphics Color D

Key Notes (typ.)

1. All sign components cut from 1/4" thick non-glare cast acrylic.
2. All graphics & background paint applied on 2nd surface.
3. All components & graphics must contrast with each other as shown.
4. Each sign must contrast with the color of the door it is mounted on.

5. Wheelchair symbol shall only be used for accessible restrooms.
6. Non accessible restrooms shall receive a blank sign
7. Signs shall be mounted to door surface with d/f foam tape & silicone
8. See detail 3/SG-4.0 for mounting locations

UNISEX w/ LIGHT DOORS



OPTIONAL INFORMATIONAL VERBIAGE WHERE APPLICABLE

1A Enlarged Elevations & Sections
Scale 1:4

FEMALE w/ LIGHT DOORS



2A Enlarged Elevations & Sections
Scale 1:4

MALE w/ LIGHT DOORS

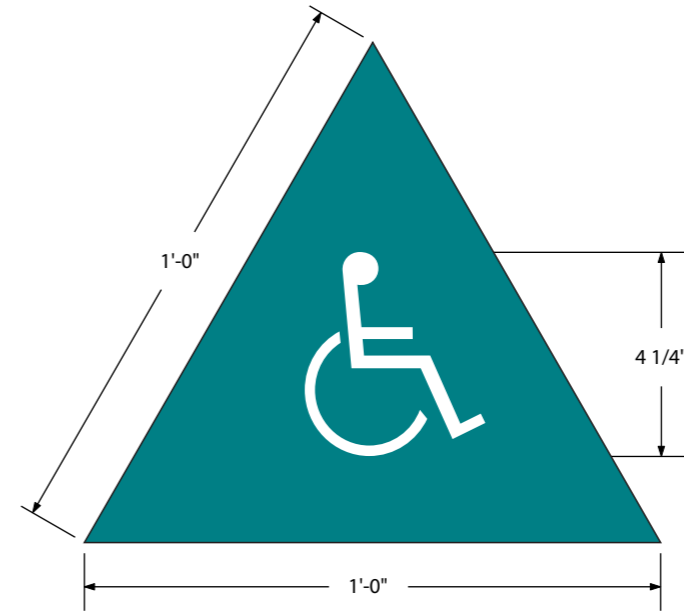

3A Enlarged Elevations & Sections
Scale 1:4

UNISEX w/ DARK DOORS



1B Enlarged Elevations & Sections
Scale 1:4

FEMALE w/ DARK DOORS



2B Enlarged Elevations & Sections
Scale 1:4

MALE w/ DARK DOORS

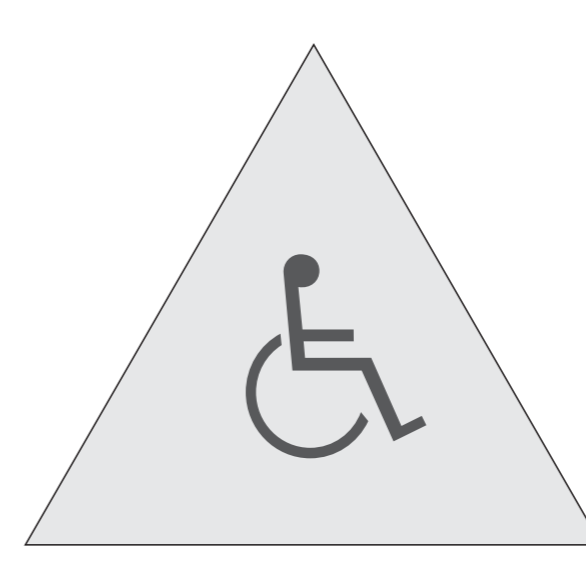

3B Enlarged Elevations & Sections
Scale 1:4



- Background Color A
- Background Color B
- Graphics Color D

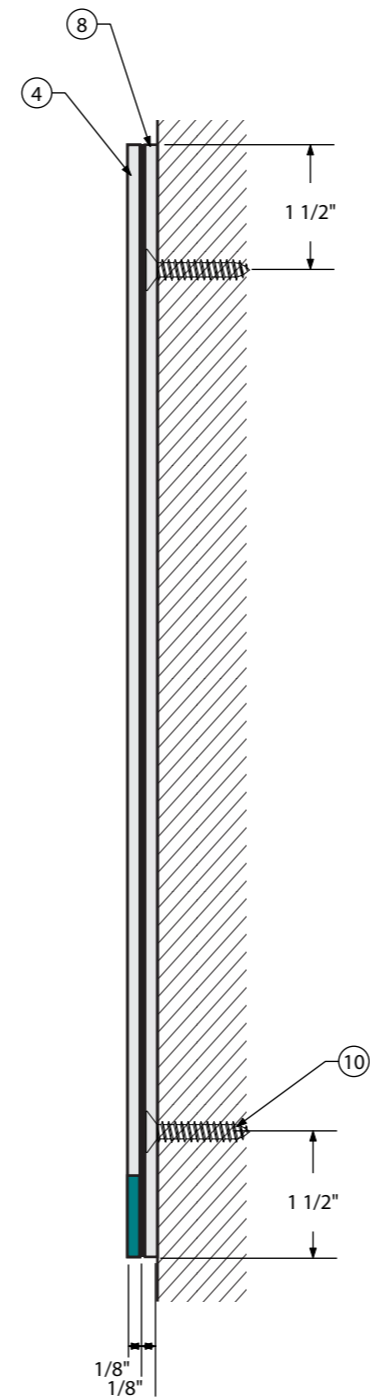
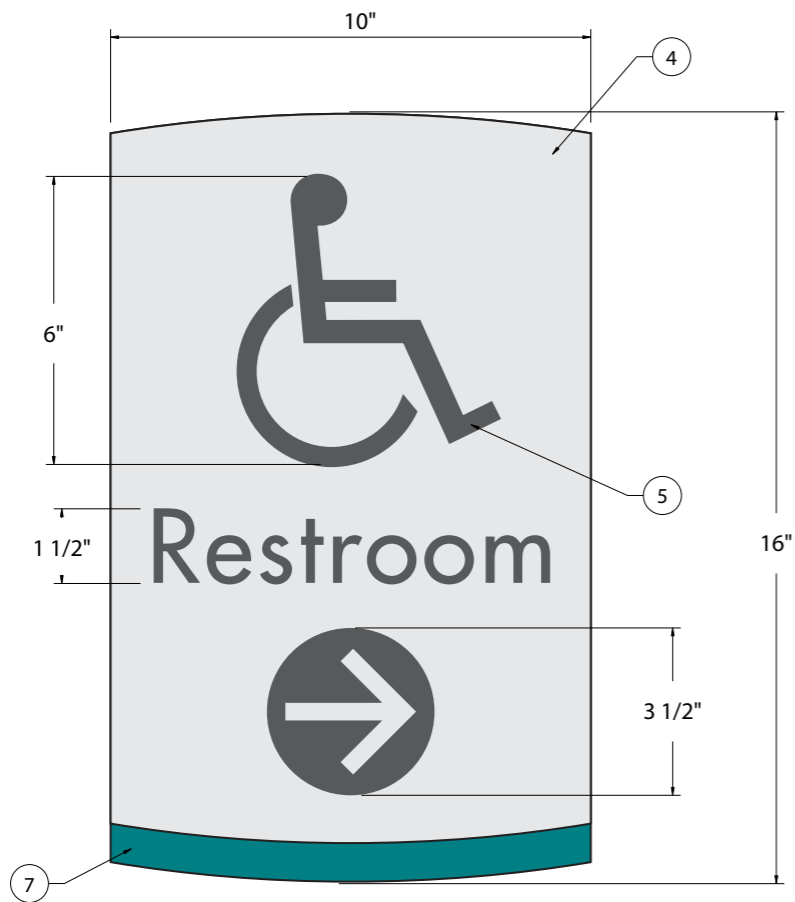

- Key Notes:
- ④ Sign plaque made from 1/8" thick clear cast non-glare acrylic. All color & graphics to be applied sub-surface.
 - ⑤ Subsurface cut-vinyl graphics
 - ⑦ Accent bar in school color
 - ⑧ White acrylic backplate mounted to wall
 - ⑨ 1/32" layer of foam adhesive to mount accent plaque on backplate.
 - ⑩ #8 x 1" corrosion resistant FH screws to mount countersunk backplate to wall.



Wheelchair symbol to follow arrow orientation when possible



① Enlarged Elevation
Scale 1:4

② Section
Scale 1:2

③ Context Elevation
Scale 1/2" = 1'



**Simple
Directional
Sign
(Wall Mount)**

Sheet Size : 11"x17"

SG-5.0

- Background Color A
- Background Color B
- Graphics Color D



1 Enlarged Elevation
Scale 1:2

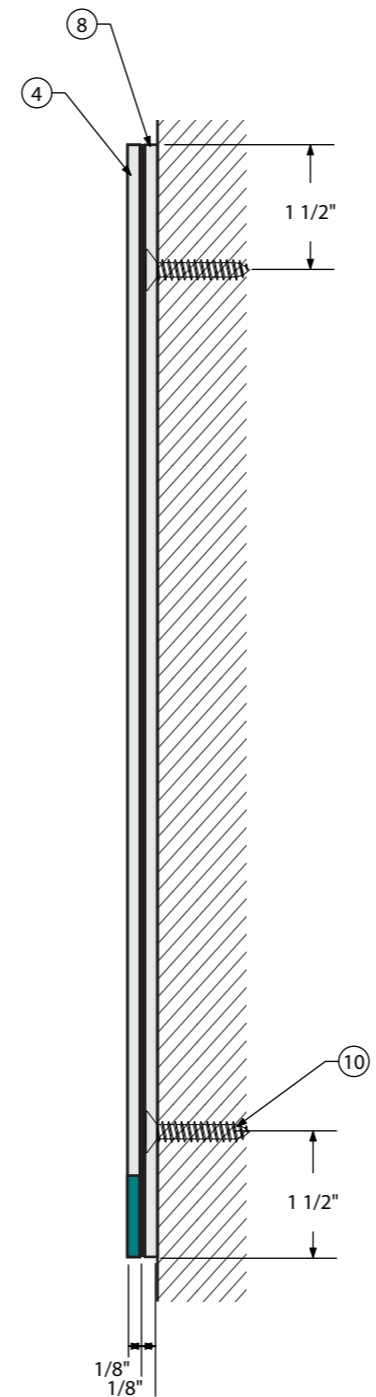

2 Section
Scale 1:2

- Key Notes:
- 4 Sign plaque made from 1/8" thick clear cast non-glare acrylic. All color & graphics to be applied sub-surface.
 - 5 Subsurface cut-vinyl graphics
 - 7 Accent bar in school color
 - 8 White acrylic backplate mounted to wall
 - 9 1/32" layer of foam adhesive to mount accent plaque on backplate.
 - 10 #8 x 1" corrosion resistant FH screws to mount countersunk backplate to wall.

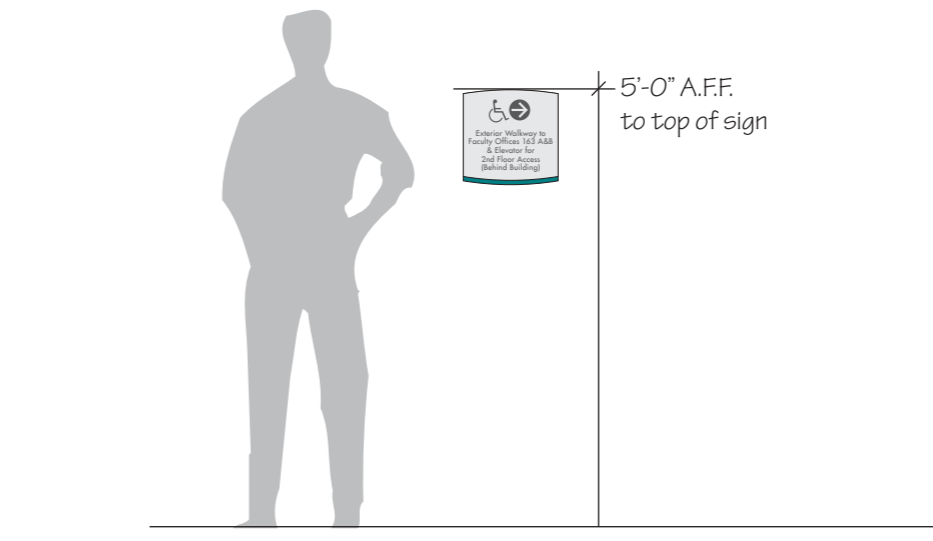

3 Context Elevation
Scale 1/2" = 1'



**Complex
Directional
Sign
(Wall Mount)**

- Background Color A
- Background Color B
- Graphics Color D



1 Enlarged Elevation
Scale 1:4

Key Notes:

- 4 Sign plaque made from .080" thick aluminum sheet stock. All color & graphics to be applied on surface and sealed w/ satin UV clear coat.
- 5 High performance cut-vinyl graphics.
- 7 Accent bar in school color
- 10 #8 x 1" corrosion resistant SM screws to mount sign to post. All hardware painted to match sign colors

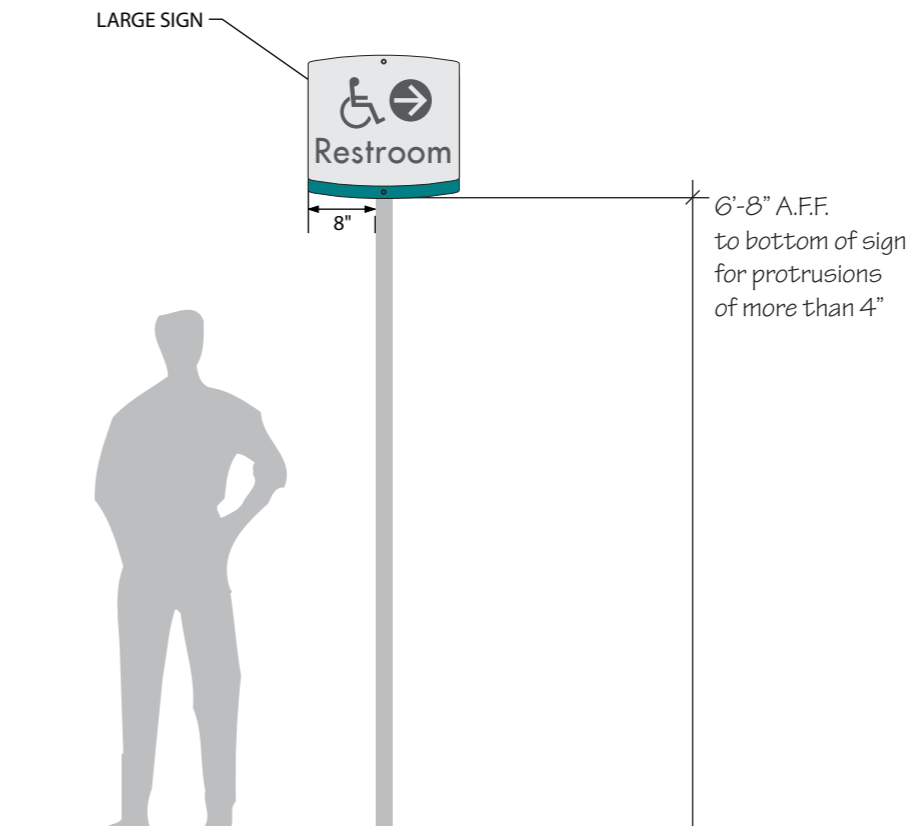

3 Context Elevation
Scale 1/2" = 1'



**Directional
Sign
(Post Mount)**

Sheet Size : 11"x17"

SG-5.2

- Background Color A
- Background Color B
- Graphics Color D

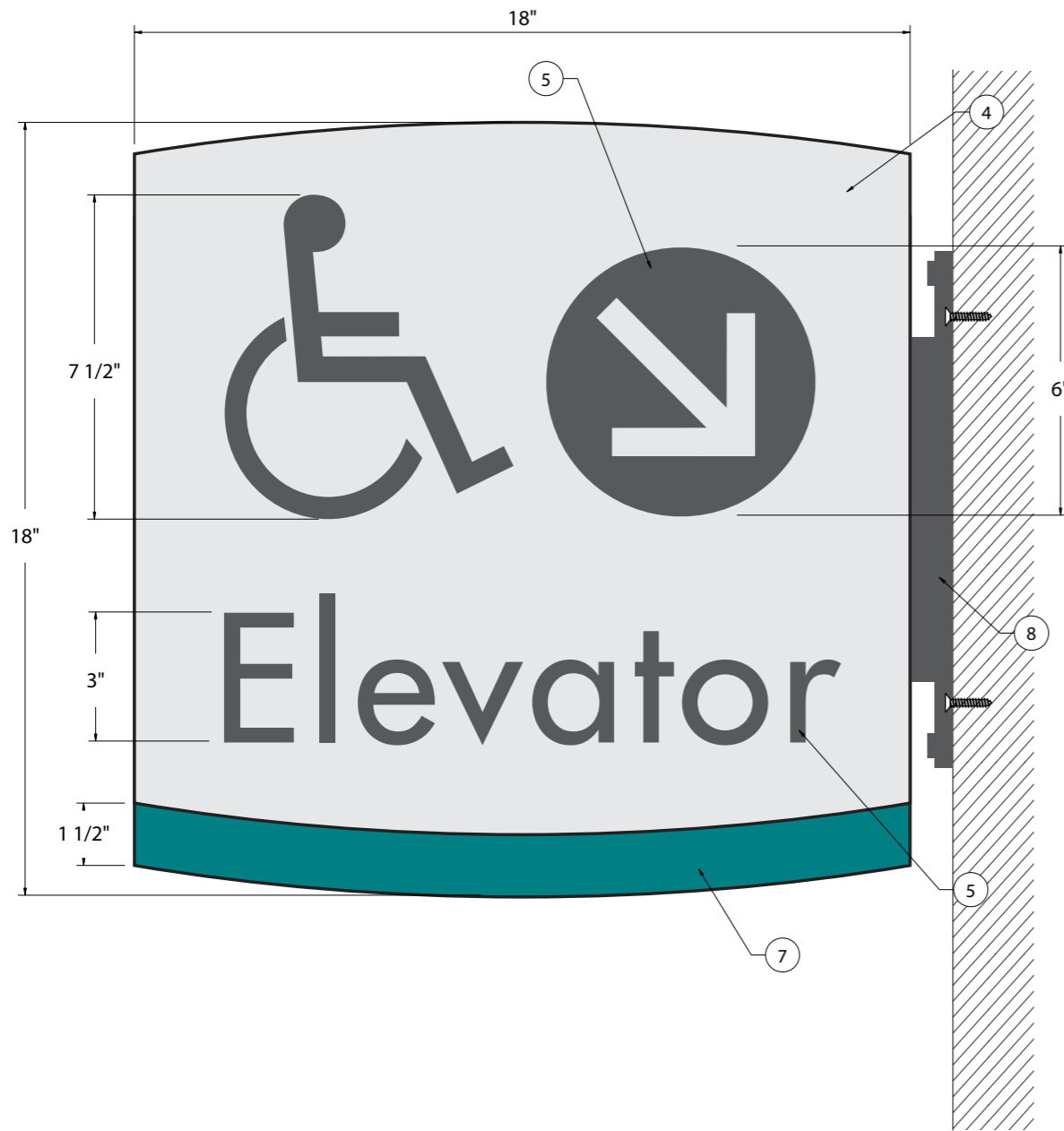

3 Alternate Versions
Scale 1:8

Key Notes:

- 4** Sign plaques made from 1/8" thick clear cast non-glare acrylic. All color & graphics to be applied sub-surface. Front and back plaque graphics are reverse.
- 5** Subsurface cut-vinyl graphics
- 7** Accent bar in school color
- 8** Aluminum wall bracket in between double sign faces (sim. to Vista™ System WB-300)
- 9** 1/32" layer of foam adhesive to mount plaques to bracket.
- 10** #8 x 1" corrosion resistant FH screws to mount countersunk mounting-plate to wall.

80" A.F.F. (typ.) min.
to bottom of sign

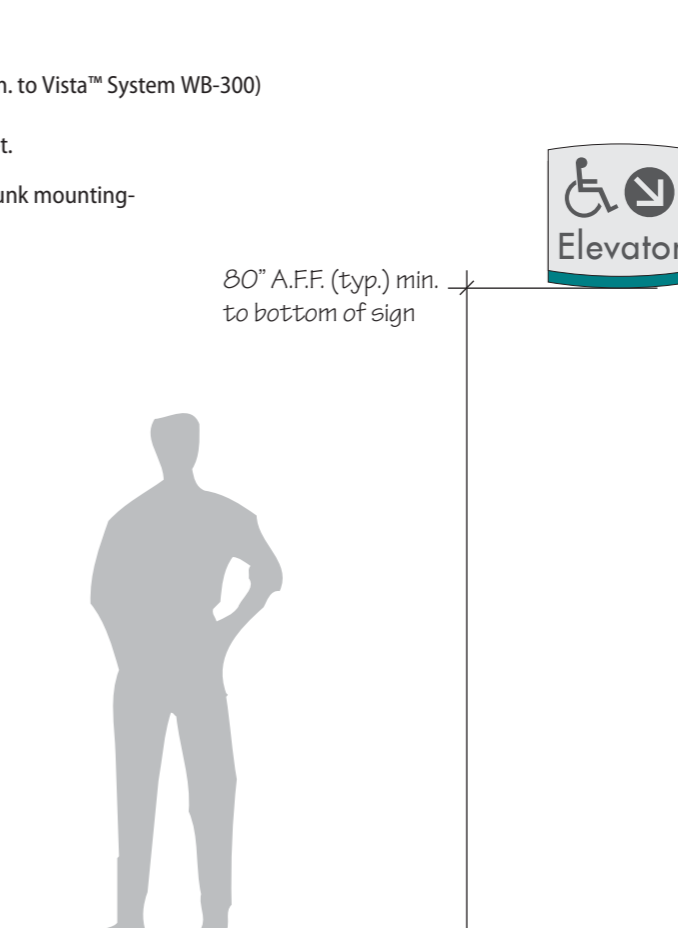

2 Projecting Blade Sign
Scale 1:4

3 Context Elevation
Scale 1/2" = 1'



**Projecting
Signs**

Sheet Size : 11"x17"

SG-5.3

- Background Color A
- Graphics Color C
- Background Color B
- Graphics Color D
- Watermark Color E



1 Vinyl Decal for mounting on doors & sidelites
Scale 1:2

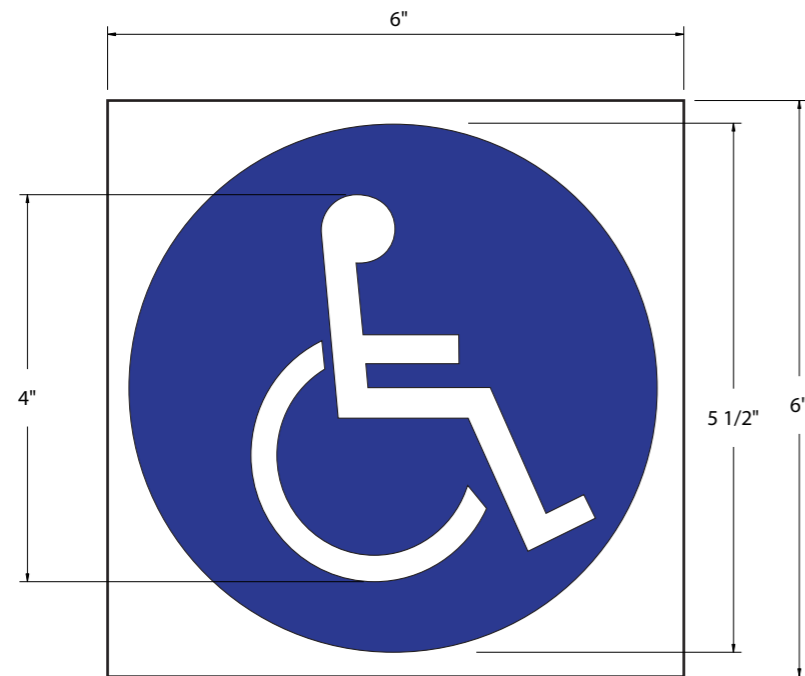

2 Acrylic Plaque for wall mounting
Scale 1:2

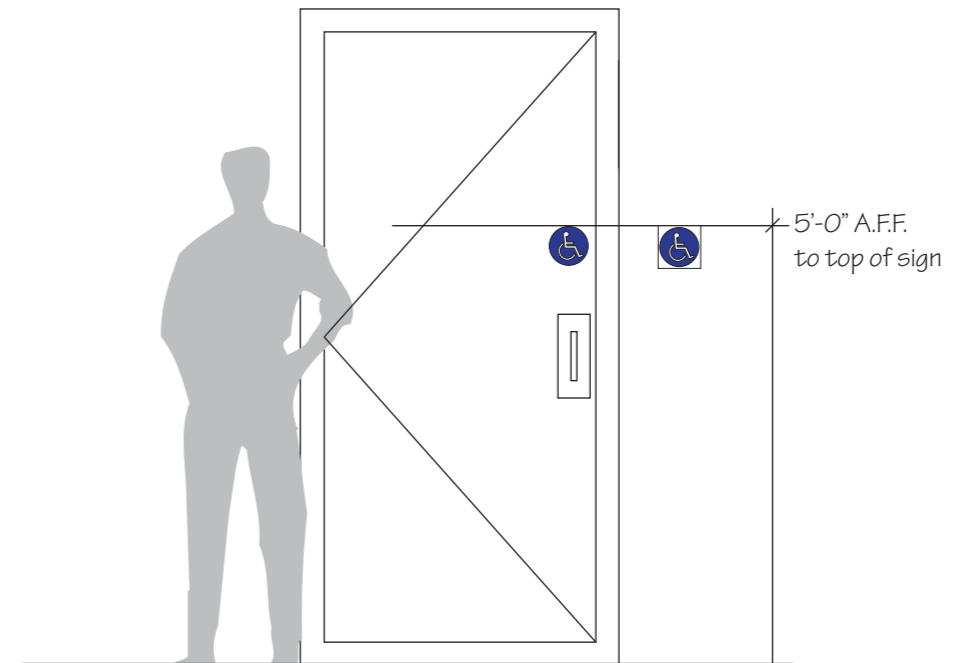

3 Context Elevation
Scale 1/2" = 1'



**International
Symbol of
Accessibility
(ISA)**

- Background Color A
- Background Color B
- Graphics Color D



1 Enlarged Elevation
Scale 1:4

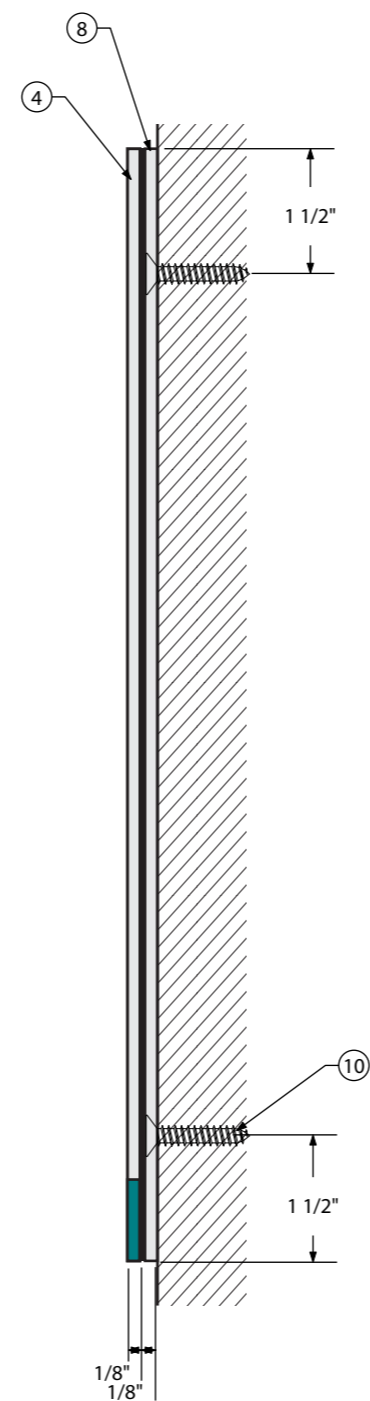

2 Section
Scale 1:2

Key Notes:

- 4 Sign plaque made from 1/8" thick clear cast non-glare acrylic. All color & graphics to be applied sub-surface.
- 5 Subsurface cut-vinyl graphics
- 7 Accent bar in school color
- 8 White acrylic backplate mounted to wall
- 9 1/32" layer of foam adhesive to mount sign plaque on backplate.
- 10 #8 x 1" corrosion resistant FH screws to mount countersunk backplate to wall.

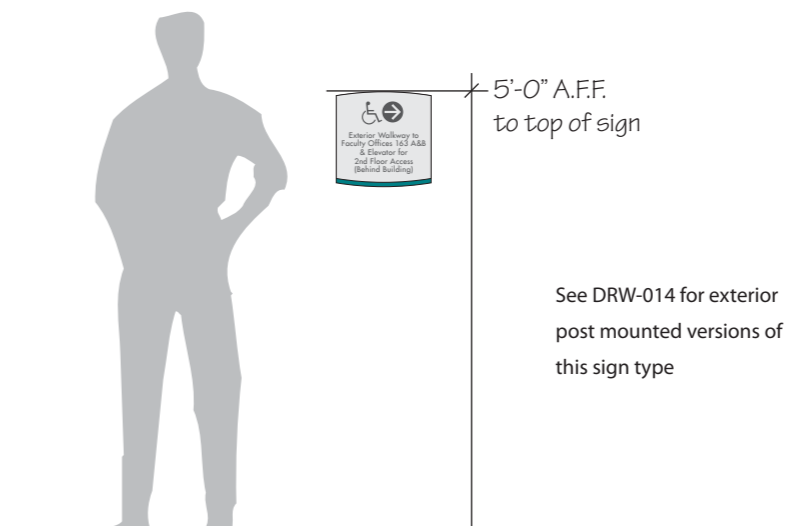

3 Context Elevation
Scale 1/2" = 1'



**Assistive
Listening
Sign**

Sheet Size : 11"x17"

SG-6.0

- Background Color A
- Background Color B
- Graphics Color D



1 Enlarged Elevation
Scale 1:4

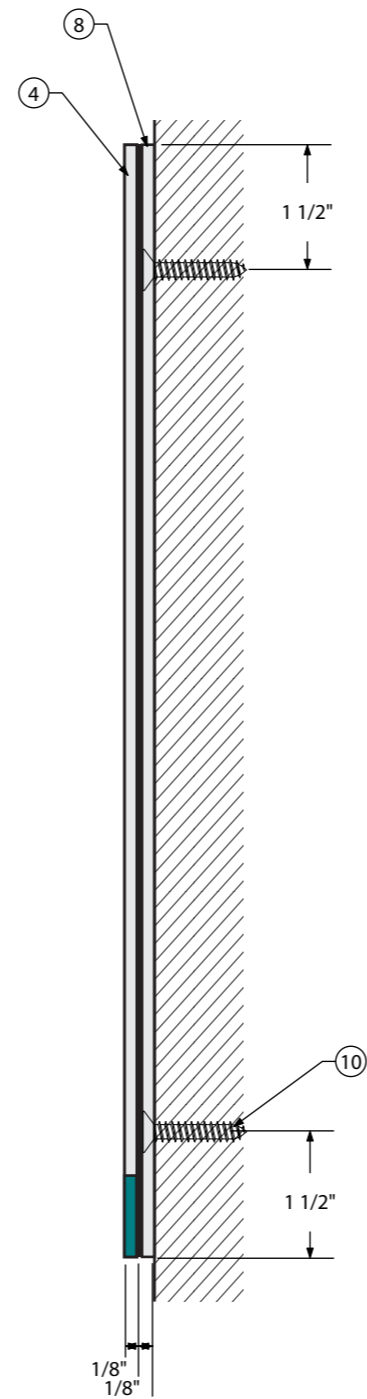

2 Section
Scale 1:2

Key Notes:

- 4 Sign plaque made from 1/8" thick clear cast non-glare acrylic. All color & graphics to be applied sub-surface.
- 5 Subsurface cut-vinyl graphics
- 7 Accent bar in school color
- 8 White acrylic backplate mounted to wall
- 9 1/32" layer of foam adhesive to mount sign plaque on backplate.
- 10 #8 x 1" corrosion resistant FH screws to mount countersunk backplate to wall.

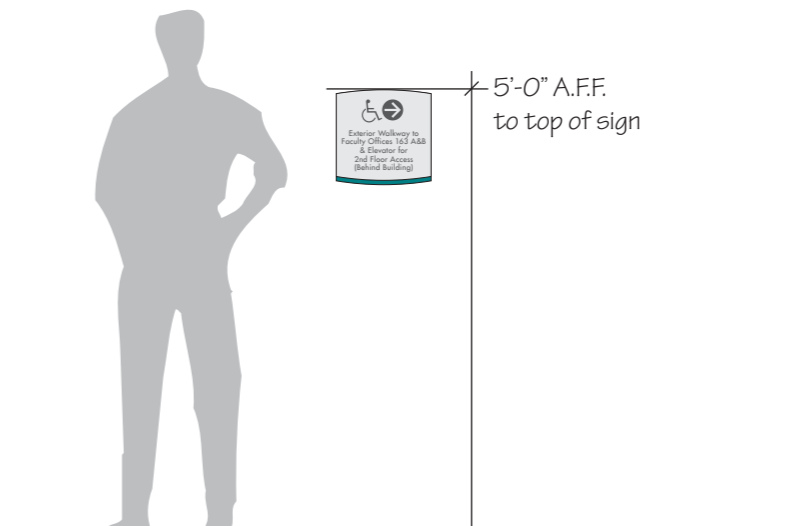

3 Context Elevation
Scale 1/2" = 1'



**Maximum
Occupancy
Sign**

Sheet Size : 11"x17"

SG-6.1

- Background Color A
- Graphics Color R
- Background Color B
- Graphics Color D



1 Enlarged Elevation
Scale 1:4

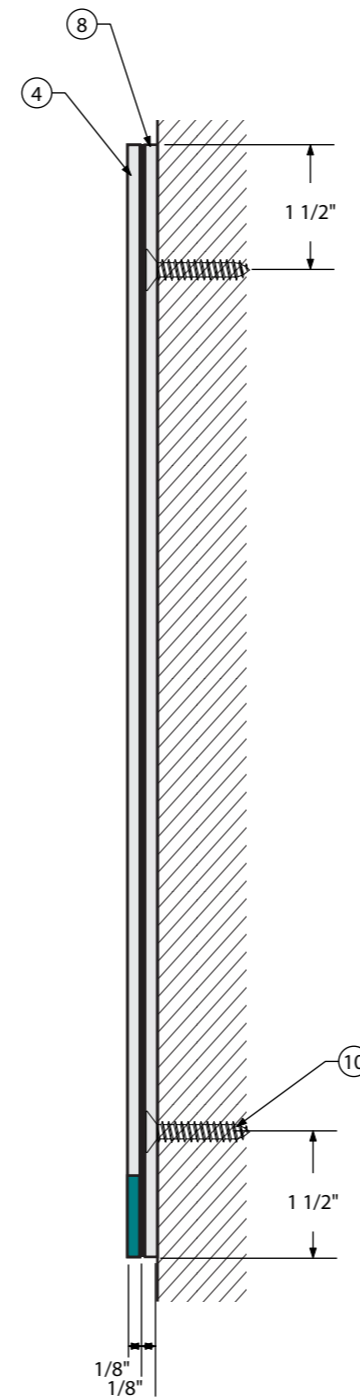

2 Section
Scale 1:2

- Key Notes:
- 4 Sign plaque made from 1/8" thick clear cast non-glare acrylic. All color & graphics to be applied sub-surface.
 - 5 Subsurface cut-vinyl graphics
 - 7 Accent bar in school color
 - 8 White acrylic backplate mounted to wall
 - 9 1/32" layer of foam adhesive to mount sign plaque on backplate.
 - 10 #8 x 1" corrosion resistant FH screws to mount countersunk backplate to wall.

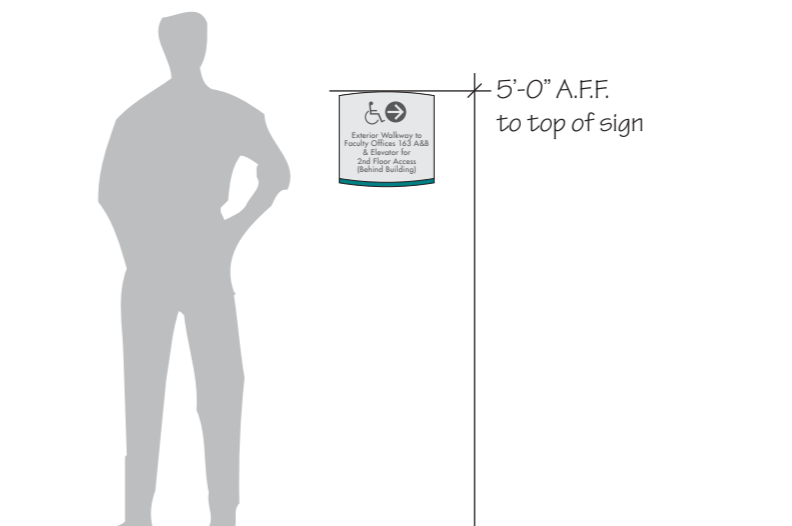

3 Context Elevation
Scale 1/2" = 1'



**Regulatory
Entrance
Sign**

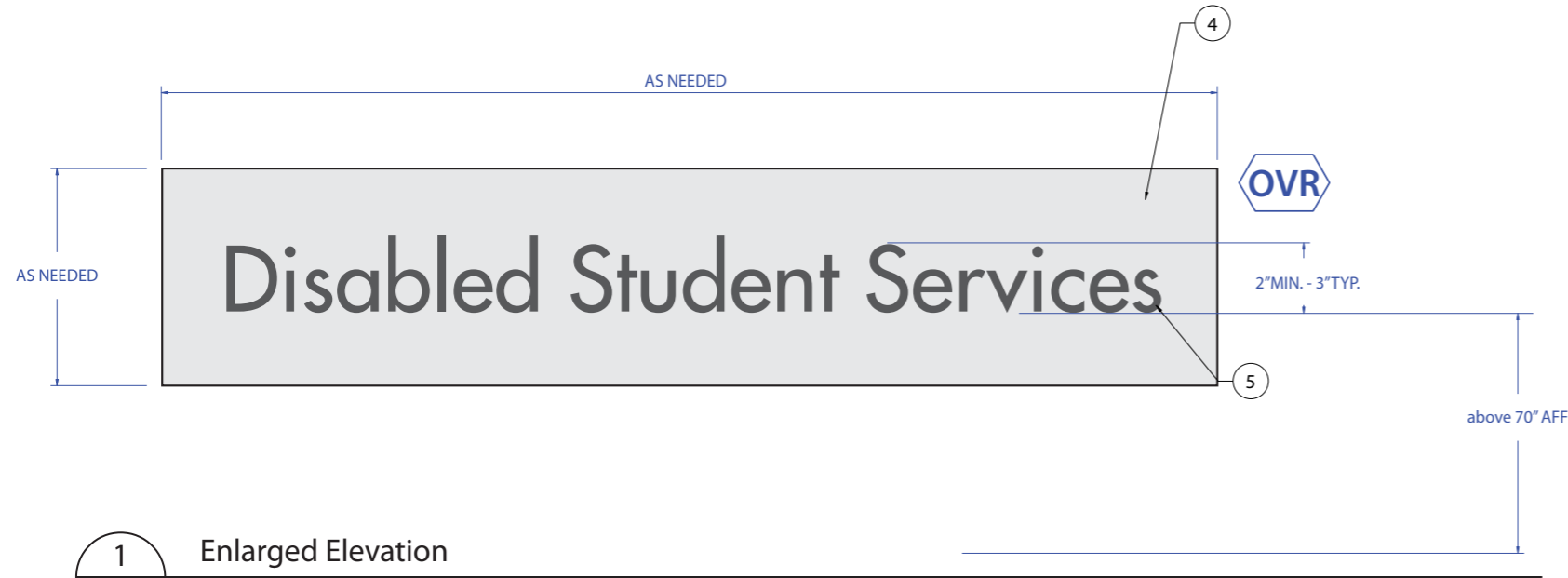

1 Enlarged Elevation
Scale NTS

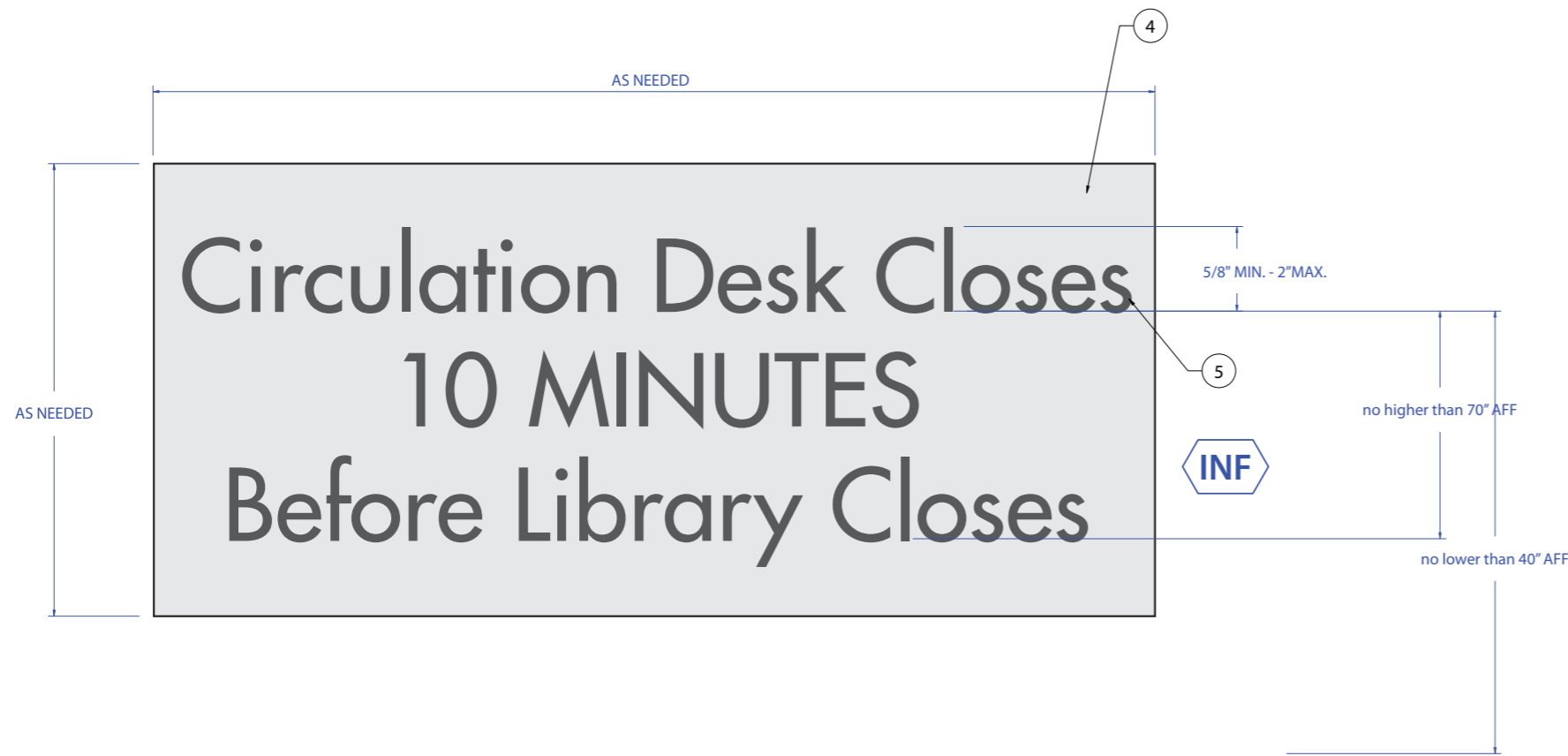

2 Enlarged Elevation
Scale NTS

- Key Notes:
- 4 Sign plaque made from 1/8" thick clear cast non-glare acrylic. All color & graphics to be applied sub-surface.
 - 5 Subsurface cut-vinyl graphics
 - 7 Not Used
 - 8 Not Used
 - 9 1/32" layer of foam adhesive to mount sign plaque on wall
 - 10 Not Used

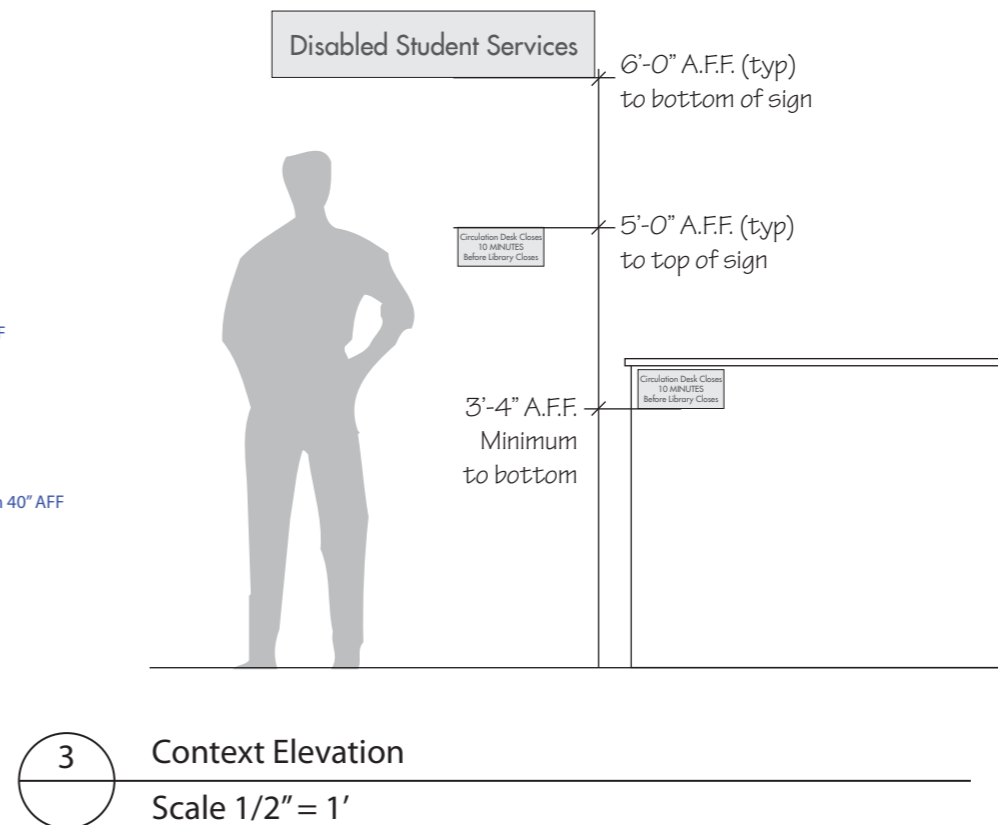

3 Context Elevation
Scale 1/2" = 1'

Access Communications
Signage Consultants
3700 Industry Ave #102
Lakewood, CA 90712
TEL (562) 423-6600
FAX (562) 981-8736

Project : Moreno Valley College
Signage Program
Client : RCCD
Contact :
Job No. :

Designer : Ullrich Hepperlin
Email: ullrich@tojico.com
Phone: (562) 212-9347

Revision : 002
Revision Date : 6-22-2017



**Miscellaneous
Informational
Signs**

Sheet Size : 11"x17"

SG-6.3

■ Background Color

□ Graphics Color

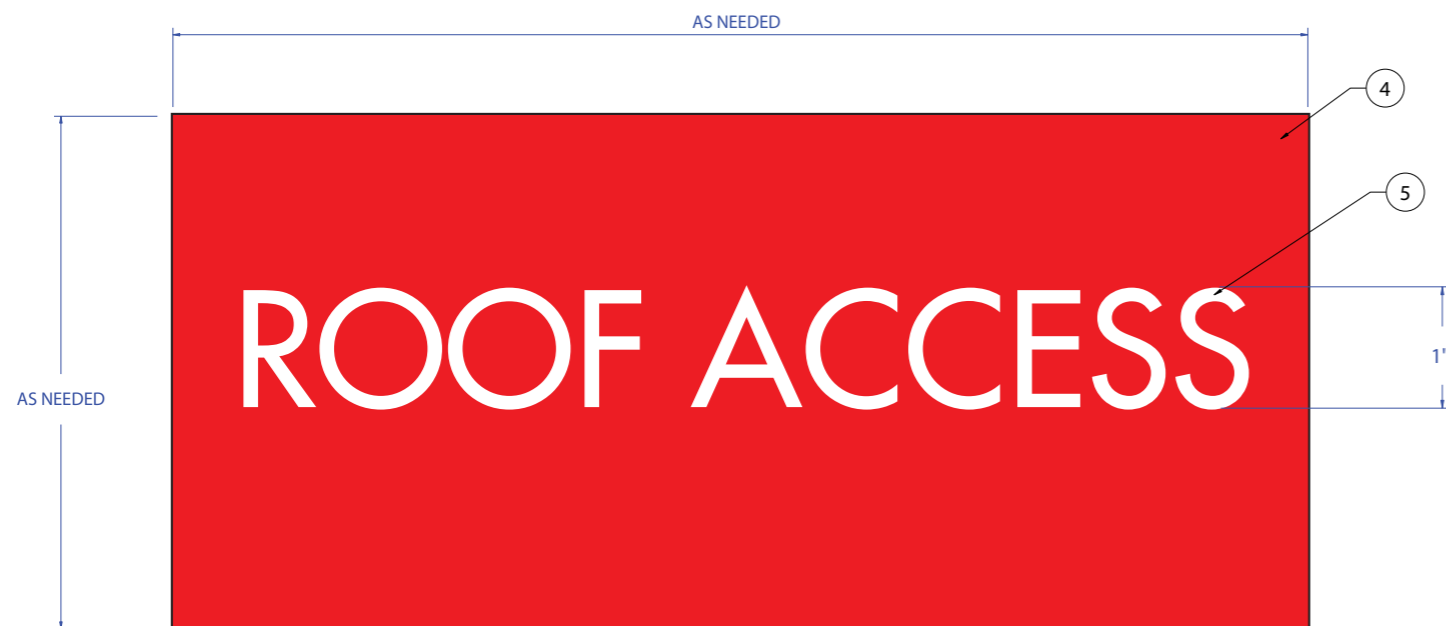

1 Enlarged Elevation
Scale NTS

Key Notes:

- 4 Sign plaque made from 1/8" thick clear cast non-glare acrylic. All color & graphics to be applied sub-surface.
- 5 Subsurface cut-vinyl graphics
- 7 Not Used
- 8 Not Used
- 9 1/32" layer of foam adhesive to mount sign plaque on door
- 10 Not Used

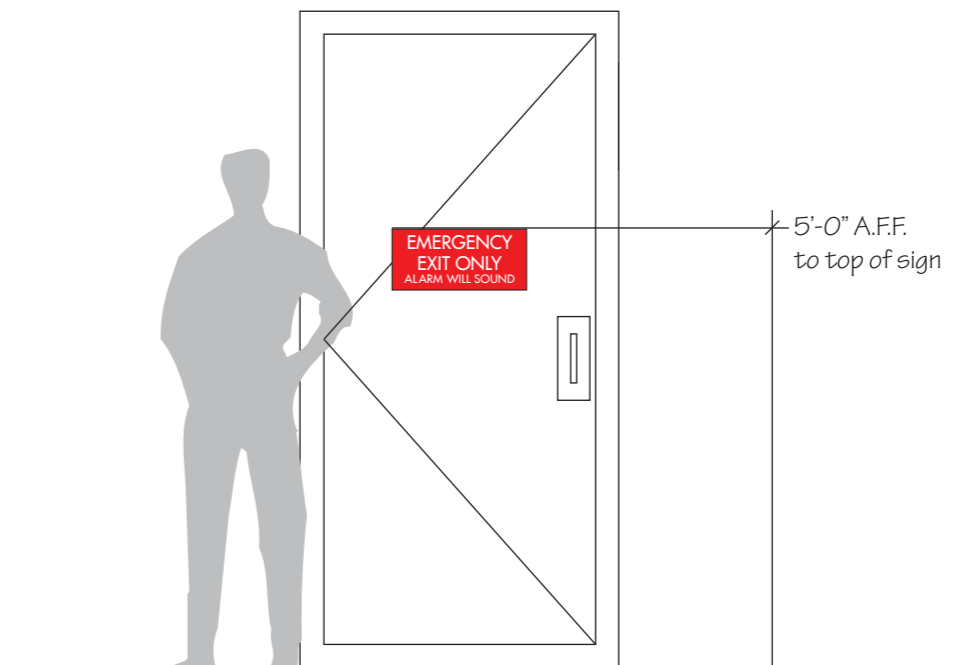

3 Context Elevation
Scale 1/2" = 1'



Roof Access Signs

Sheet Size : 11"x17"

SG-6.4

■ Background Color

□ Graphics Color

Access Communications
Signage Consultants
3700 Industry Ave #102
Lakewood, CA 90712
TEL (562) 423-6600
FAX (562) 981-8736

Project : Moreno Valley College
Signage Program
Client : RCCD
Contact :
Job No. :

Designer : Ullrich Hepperlin
Email: ullrich@tojico.com
Phone: (562) 212-9347

Revision : 002
Revision Date : 6-22-2017



Regulatory Informational Signs

Sheet Size : 11"x17"

SG-6.5

Key Notes:

- ④ Sign plaque made from 1/8" thick clear cast non-glare acrylic. All color & graphics to be applied sub-surface.
- ⑤ Subsurface cut-vinyl graphics
- ⑦ Not Used
- ⑧ Not Used
- ⑨ 1/32" layer of foam adhesive to mount sign plaque on door
- ⑩ Not Used

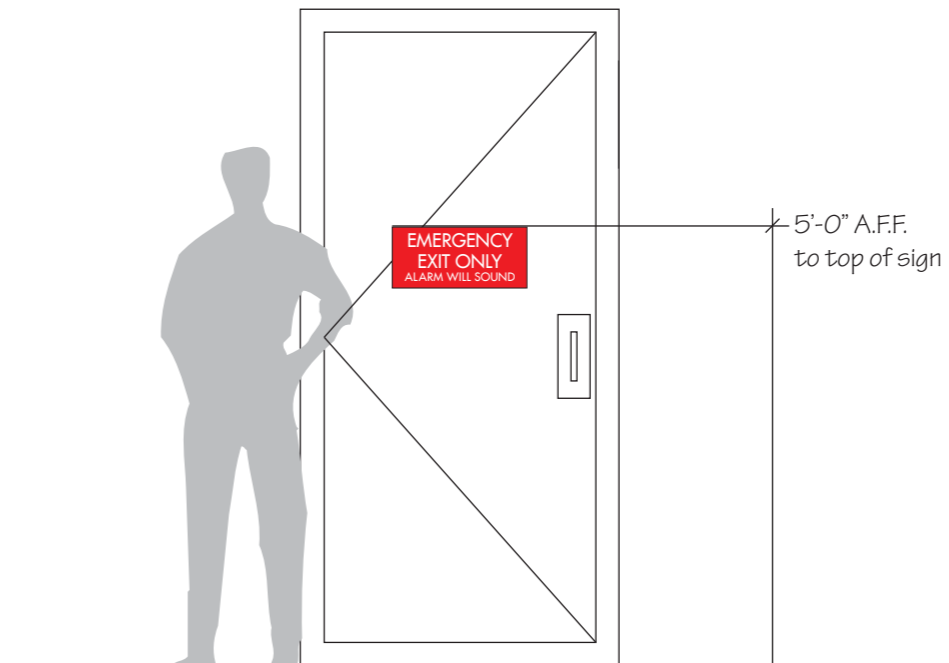

① Enlarged Elevation
Scale NTS

③ Context Elevation
Scale 1/2" = 1'

- Background Color
- Background Color
- Background Color
- Background Color
- Graphics Color
- Graphics Color
- Graphics Color
- Graphics Color

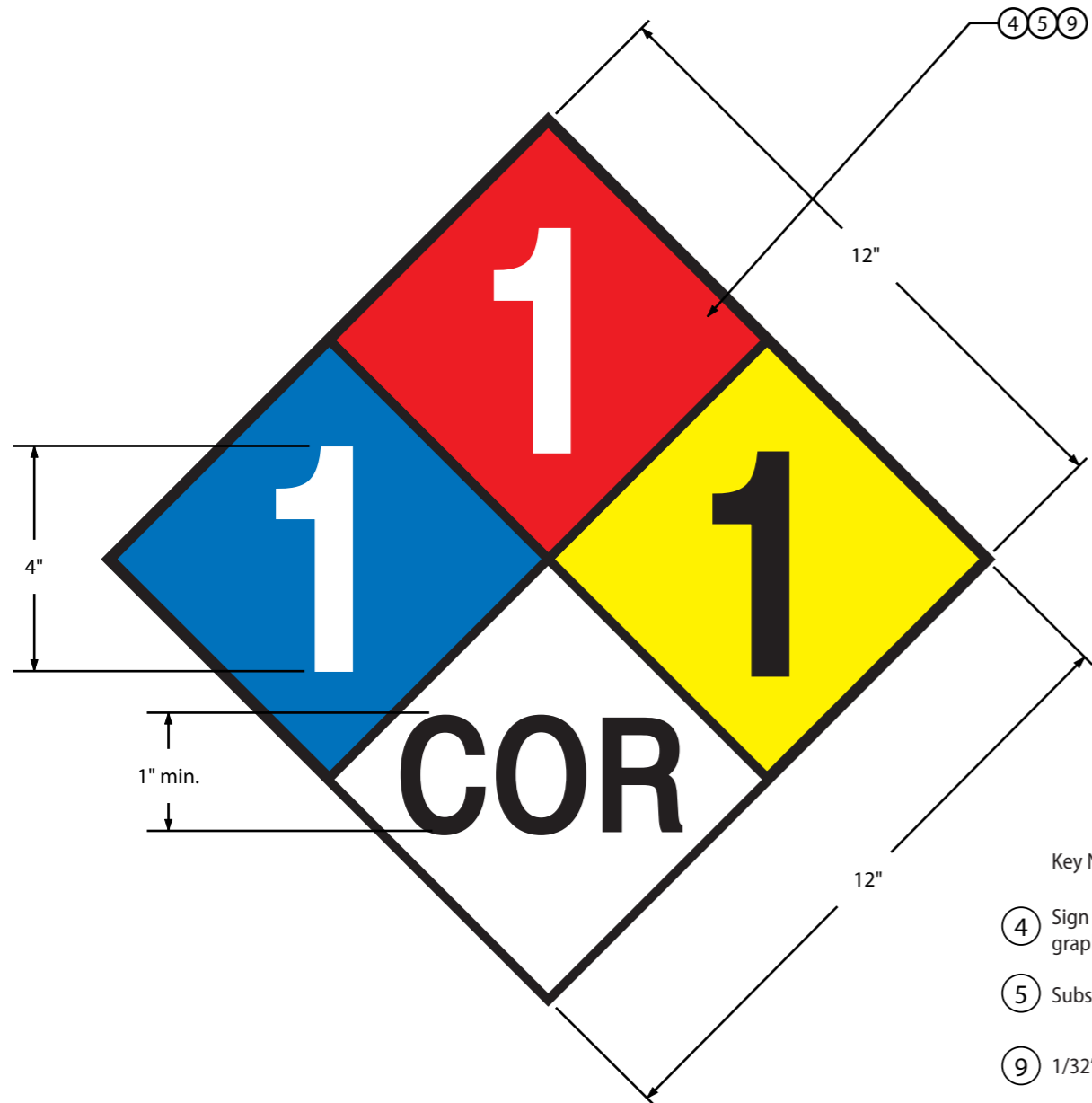

- Key Notes:
- ④ Sign plaque made from 1/8" thick clear cast non-glare acrylic. All color & graphics to be applied sub-surface.
 - ⑤ Subsurface vinyl graphics
 - ⑨ 1/32" layer of foam adhesive to mount sign plaque on door

① Enlarged Elevation
Scale NTS

③ Context Elevation
Scale 1/2" = 1'

NFPA Rating Explanation Guide					
RATING NUMBER	HEALTH HAZARD	FLAMMABILITY HAZARD	INSTABILITY HAZARD	RATING SYMBOL	SPECIAL HAZARD
4	Can be lethal	Will vaporize and readily burn at normal temperatures	May explode at normal temperatures and pressures	ALK	Alkaline
3	Can cause serious or permanent injury	Can be ignited under almost all ambient temperatures	May explode at high temperature or shock	ACID	Acidic
2	Can cause temporary incapacitation or residual injury	Must be heated or high ambient temperature to burn	Violent chemical change at high temperatures or pressures	COR	Corrosive
1	Can cause significant irritation	Must be preheated before ignition can occur	Normally stable. High temperatures make unstable	OX	Oxidizing
0	No hazard	Will not burn	Stable		Radioactive
					Reacts violently or explosively with water
					Reacts violently or explosively with water and oxidizing

This chart for reference only - For complete specifications consult the NFPA 704 Standard

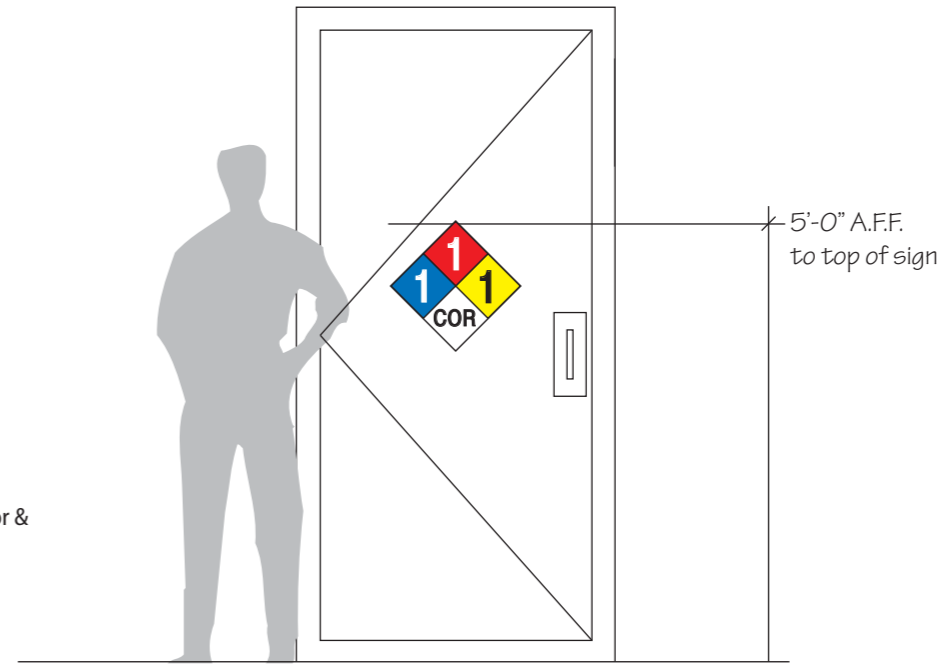

Access Communications
Signage Consultants
3700 Industry Ave #102
Lakewood, CA 90712
TEL (562) 423-6600
FAX (562) 981-8736

Project : Moreno Valley College
Signage Program
Client : RCCD
Contact :
Job No. :

Designer : Ullrich Hepperlin
Email: ullrich@tojico.com
Phone: (562) 212-9347

Revision : 002
Revision Date : 6-22-2017



Hazmat Signs

Sheet Size : 11"x17"

SG-6.6

Background Color B

Graphics Color C

Access Communications Signage Consultants 3700 Industry Ave #102 Lakewood, CA 90712 TEL (562) 423-6600 FAX (562) 981-8736

Project : Moreno Valley College Signage Program Client : RCCD Contact : Job No. :

Designer : Ullrich Hepperlin Email: ullrich@tojico.com Phone: (562) 212-9347

Revision : 002 Revision Date : 6-22-2017



Evacuation Plans

Sheet Size : 11"x17"

SG-7.0

Key Notes:

- ④ Sign face made from 1/8" thick clear cast non-glare acrylic. All color & graphics to be applied sub-surface.
- ⑤ Subsurface cut-vinyl graphics for permanent header & footer.
- ⑦ 11"x 13" cardstock insert w/ evacuation plan graphics
- ⑧ White acrylic backplate mounted to wall
- ⑨ 1/32" layer of foam adhesive to mount accent plaque on backplate.
- ⑩ #8 x 1" corrosion resistant FH screws to mount countersunk backplate to wall.

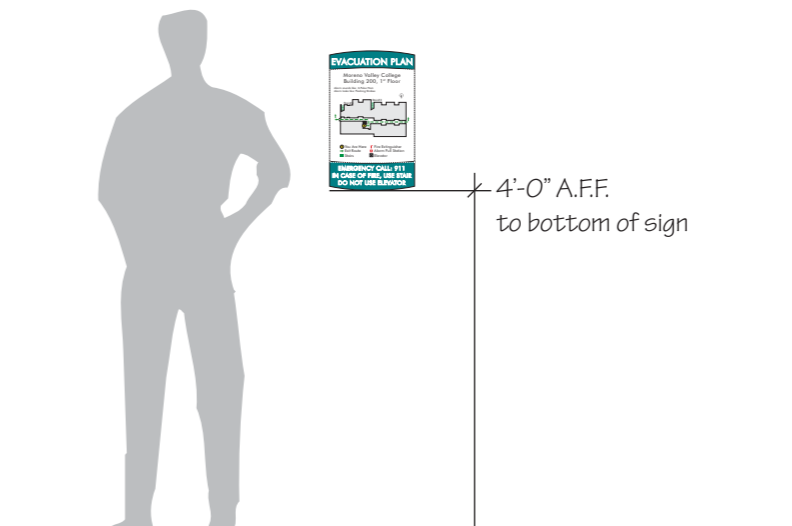
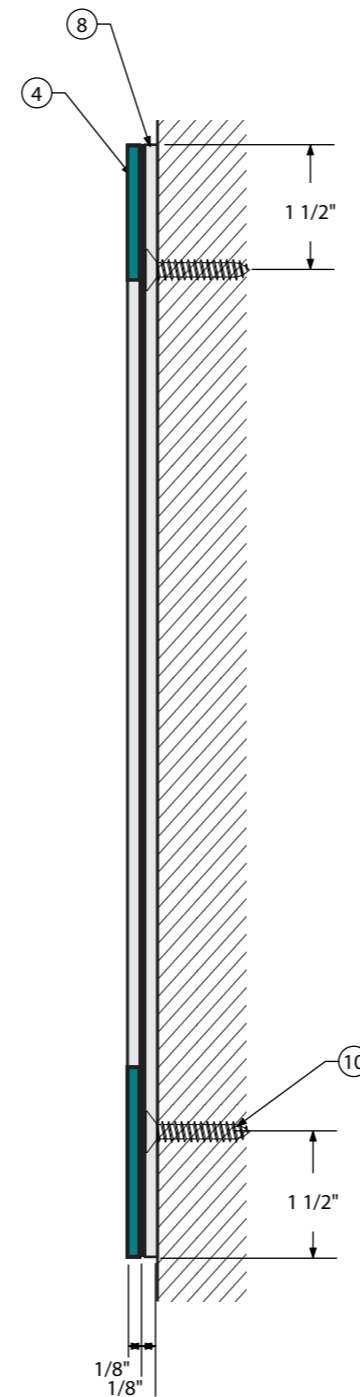

1 Enlarged Elevation Scale 1:4

2 Section Scale 1:2

3 Context Elevation Scale 1/2" = 1'

- Background Color A
- Background Color B
- Graphics Color C
- Graphics Color D
- Watermark Color E

Key Notes:

- ① Main graphic face plaque cut from 1/8" thick non-glare cast acrylic. All graphics reverse-applied on 2nd surface. No background color on this layer
- ② Subsurface cut-vinyl graphics. Removable & replaceable if needed.
- ③ Center plaque cut from 1/8" thick cast acrylic. Watermark graphics reverse-applied on 2nd surface. Main background color on this layer
- ④ Backboard made from 1/8" thick clear cast non-glare acrylic. All color & graphics to be applied sub-surface.
- ⑤ White acrylic backplate mounted to wall
- ⑥ 1/2" dia. brushed aluminum multi-mount stand-offs to hold both the face plaque and the center plaque. Stand-off barrels to be screwed onto S.S. F.H. machine bolt countersunk into backboard from the rear.
- ⑦ School logo in school color
- ⑧ MVC mountain lion watermark graphic (cut or digitally printed vinyl) on center plaque
- ⑨ 1/32" layer of foam adhesive to mount sign plaque on backplate. Window slot for name insert is left as void and framed by foam tape on top and bottom.
- ⑩ #10 x 1.5" corrosion resistant FH screws to mount countersunk backplate to wall.

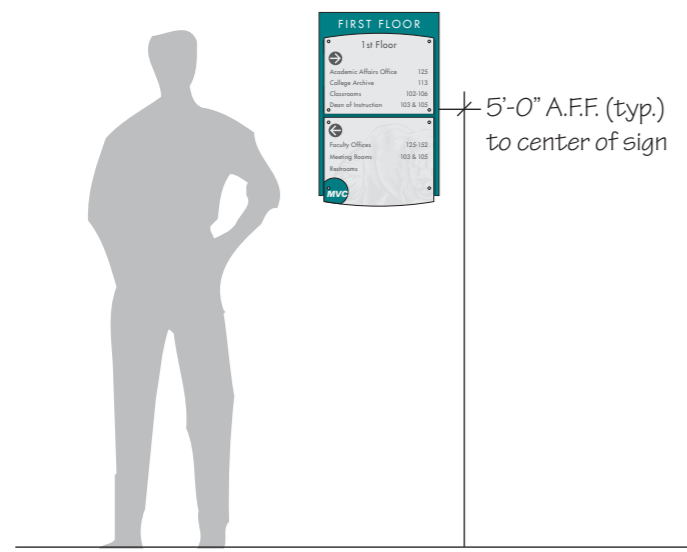

all elevation dimensions are "[...] or as required" (typ.) to accommodate various buildings, floors etc.

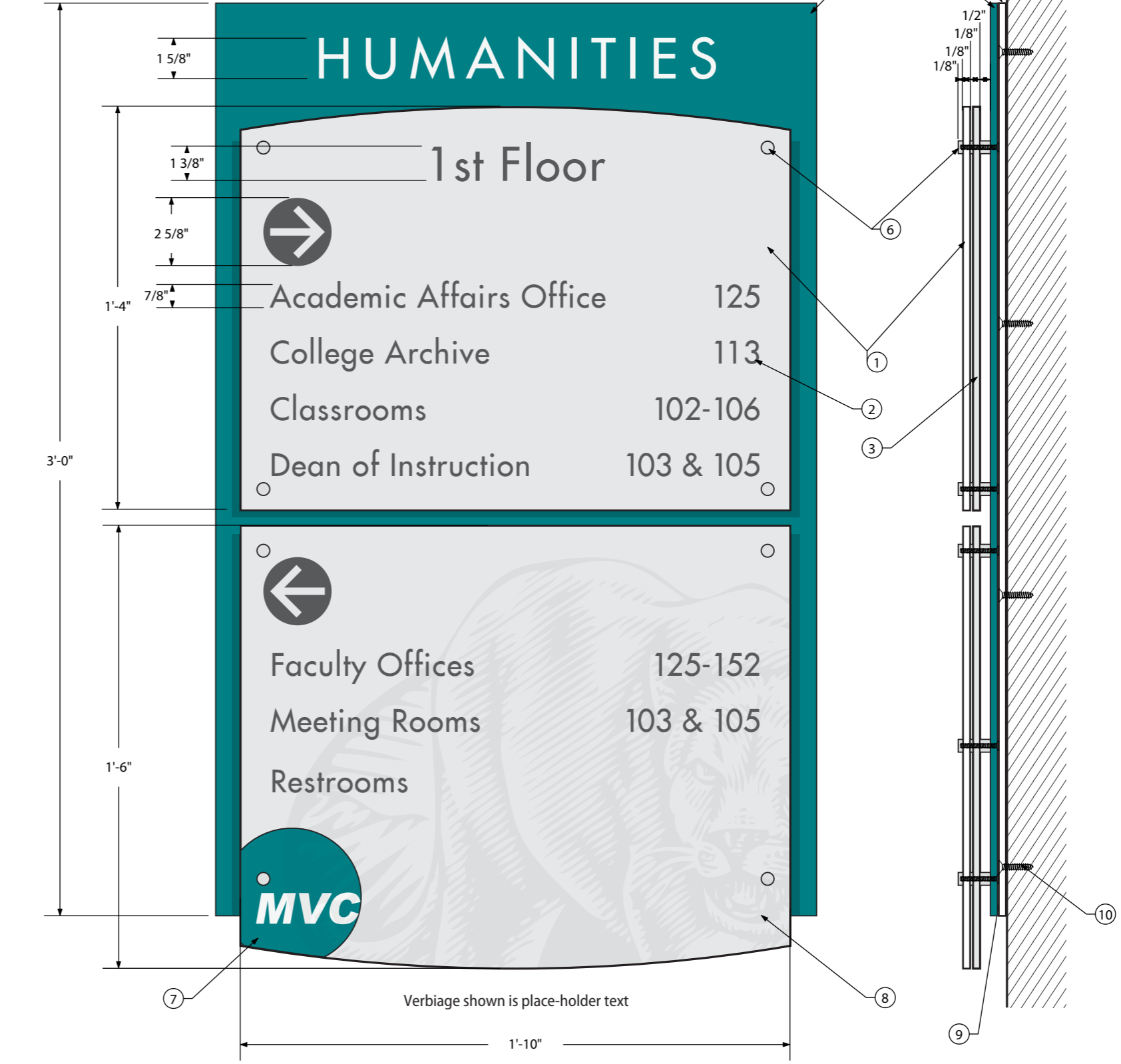

③ Context Elevation
Scale 1/2" = 1'

② Enlarged Elevation
Scale 1:5

① Section
Scale 1:5



**Floor
Director
Center of
Corridor
Version**

Sheet Size : 11"x17"

SG-8.0

- Background Color A
- Background Color B
- Graphics Color C
- Graphics Color D
- Watermark Color E

Key Notes:

- ① Main graphic face plaque cut from 1/8" thick non-glare cast acrylic. All graphics reverse-applied on 2nd surface. No background color on this layer
- ② Subsurface cut-vinyl graphics. Removable & replaceable if needed.
- ③ Center plaque cut from 1/8" thick cast acrylic. Watermark graphics reverse-applied on 2nd surface. Main background color on this layer
- ④ Backboard made from 1/8" thick clear cast non-glare acrylic. All color & graphics to be applied sub-surface.
- ⑤ White acrylic backplate mounted to wall
- ⑥ 1/2" dia. brushed aluminum multi-mount stand-offs to hold both the face plaque and the center plaque. Stand-off barrels to be screwed onto S.S. F.H. machine bolt countersunk into backboard from the rear.
- ⑦ School logo in school color
- ⑧ MVC mountain lion watermark graphic (cut or digitally printed vinyl) on center plaque
- ⑨ 1/32" layer of foam adhesive to mount sign plaque on backplate. Window slot for name insert is left as void and framed by foam tape on top and bottom.
- ⑩ #10 x 1.5" corrosion resistant FH screws to mount countersunk backplate to wall.

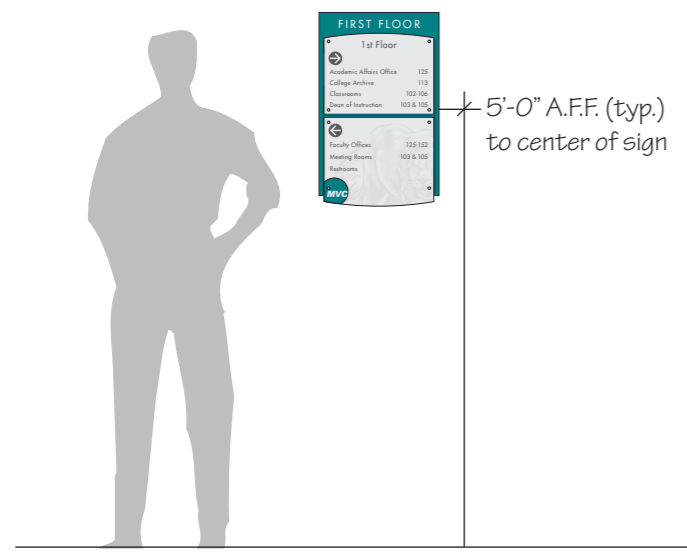

all elevation dimensions are "[...] or as required" (typ.) to accommodate various buildings, floors etc.

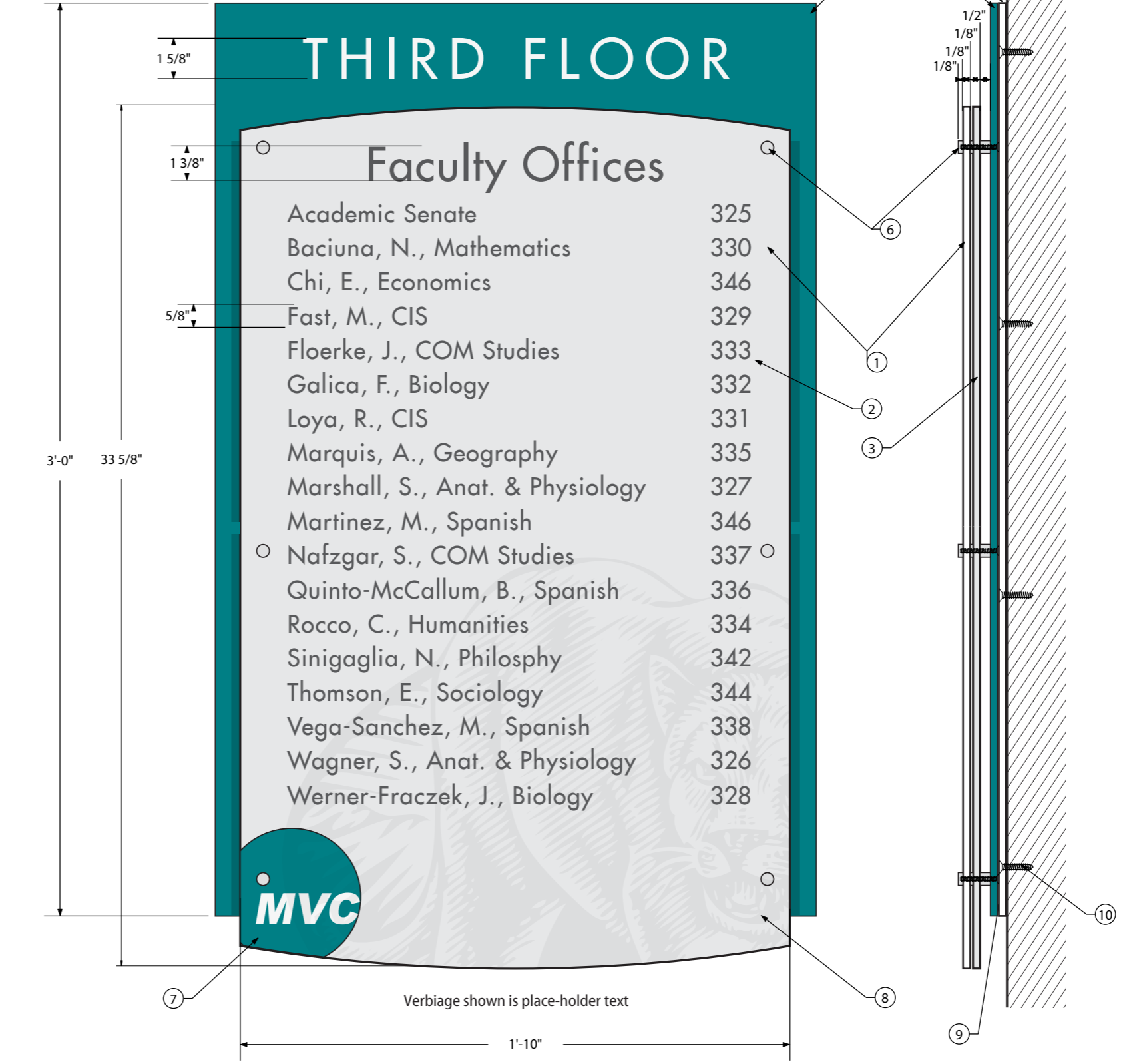

③ Context Elevation
Scale 1/2" = 1'

② Enlarged Elevation
Scale 1:5

① Section
Scale 1:5



**Floor
Directory
Building
Entrance
Version**

Sheet Size : 11"x17"

SG-8.1

- Background Color A
- Background Color B
- Graphics Color C
- Graphics Color D
- Watermark Color E

all elevation dimensions are "[...] or as required" (typ.)
to accommodate various buildings, floors etc.

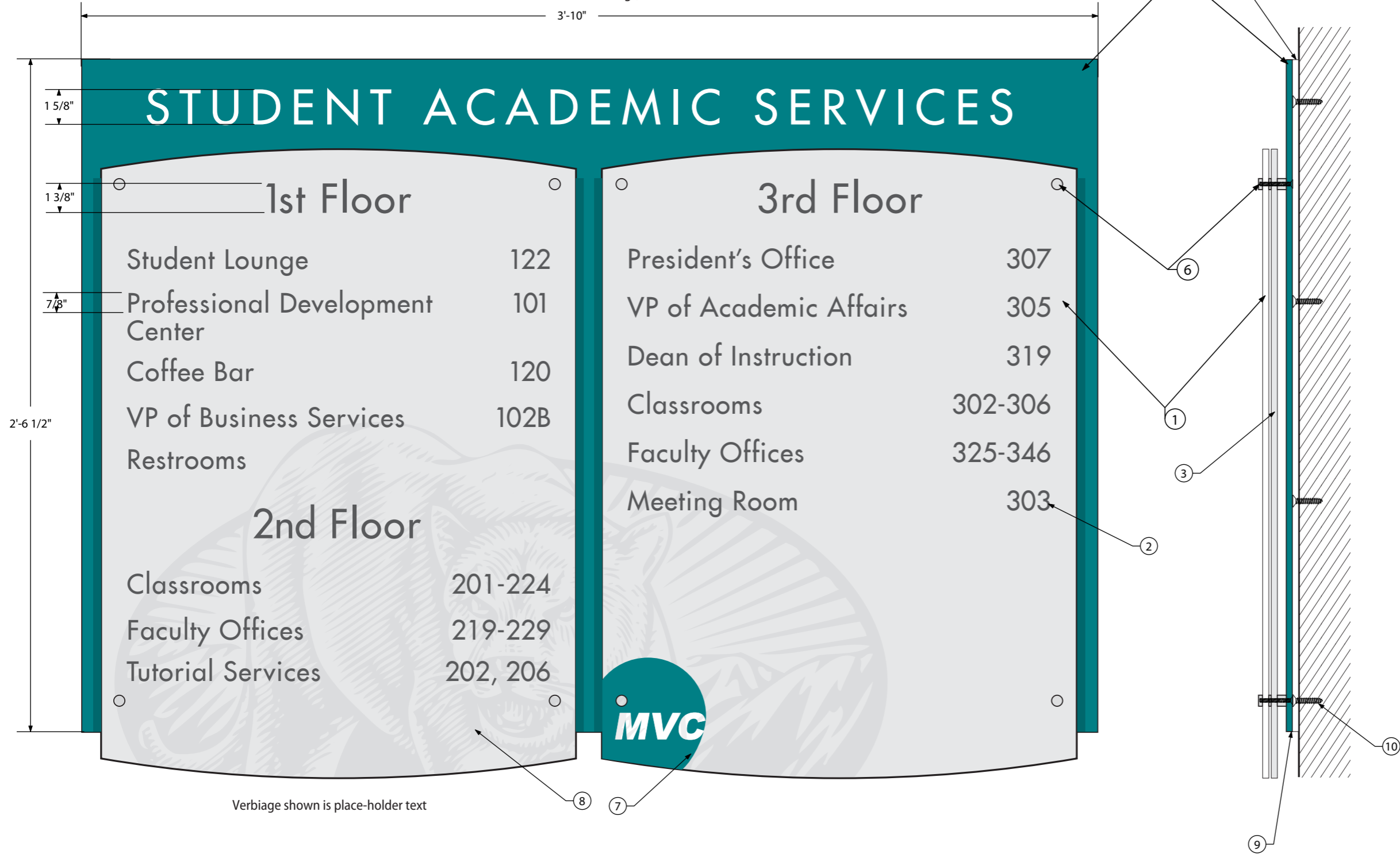

SEE SG-8.0 FOR ALL KEY NOTES

2 Enlarged Elevation
Scale 1:5

1 Section
Scale 1:5



**Building
Directory
Wall Mounted
Version**

Sheet Size : 11"x17"

SG-8.2

- Background Color A
- Background Color B
- Graphics Color C
- Graphics Color D
- Watermark Color E

all elevation dimensions are "[...] or as required" (typ.)
to accommodate various buildings, floors etc.

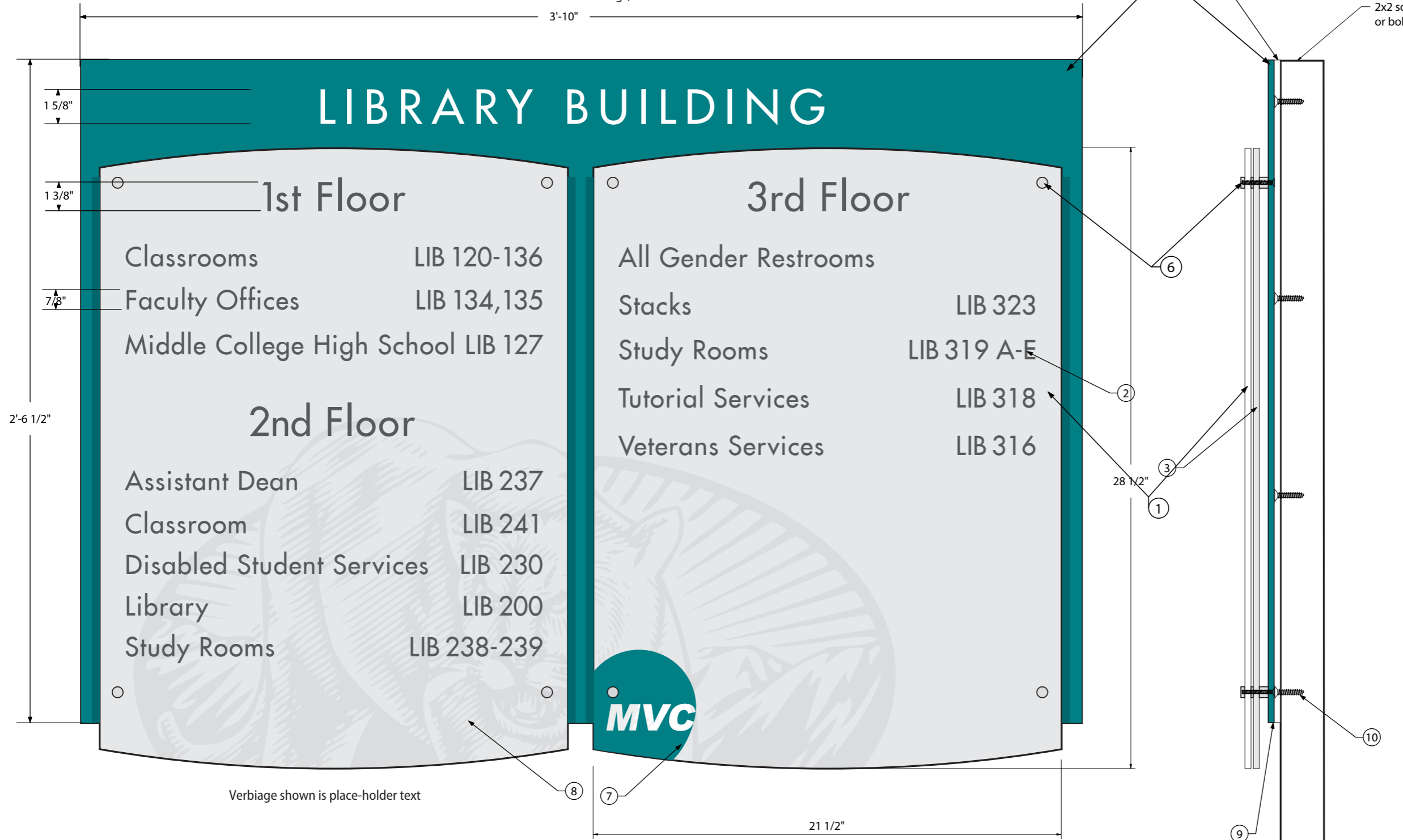

2 Enlarged Elevation
Scale 1:5

1 Section
Scale 1:5



**Building
Directory
Post Mounted
Version**

Sheet Size : 11"x17"

SG-8.3